

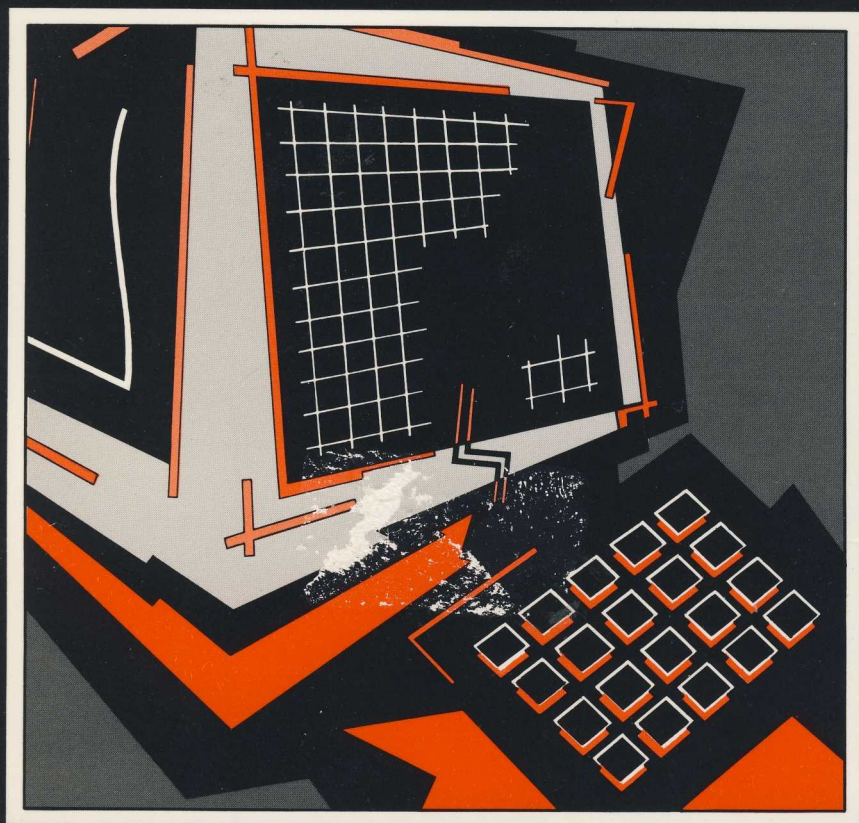

BRITISH BROADCASTING CORPORATION

MICROCOMPUTER SYSTEM

Advanced Teletext System USER GUIDE





Advanced Teletext System USER GUIDE

WARNING: THE TELETEXT ADAPTOR MUST BE EARTHED

Important: The wires in the mains lead for the Teletext Adaptor are coloured in accordance with the following code:

Green and yellow	Earth
Blue	Neutral
Brown	Live

As the colours of the wires may not correspond with the coloured markings identifying the terminals in your plug, proceed as follows:

The wire which is coloured green and yellow must be connected to the terminal in the plug which is marked by the letter E, or by the safety earth symbol, or coloured green, or green and yellow.

The wire which is coloured blue must be connected to the terminal which is marked with the letter N, or coloured black or blue.

The wire which is coloured brown must be connected to the terminal which is marked with the letter L, or coloured red or brown.

If the socket outlet is not suitable for the plug supplied, the plug should be cut off and the appropriate plug fitted and wired as previously noted. The moulded plug which was cut off should be disposed of as it would be a potential shock hazard if it were to be plugged in with the cut off end of the mains cord exposed. The moulded plug must be used with the fuse and fuse carrier firmly in place. The fuse carrier is of the same basic colour* as the coloured insert in the base of the plug. Different manufacturer's plugs and fuse carriers are not interchangeable. In the event of loss of the fuse carrier, the moulded plug **MUST NOT** be used. Either replace the moulded plug with another conventional plug wired as previously described, or obtain a replacement fuse carrier from an authorised BBC Microcomputer dealer. In the event of the fuse blowing it should be replaced, after clearing any faults, with a 3 amp fuse that is ASTA approved to BS1362.

* Not necessarily the same shade of that colour.

Within this manual and associated software, the letters BBC refer to the British Broadcasting Corporation. The term 'BBC Micro' refers to the computer manufactured by Acorn Computer PLC under licence from the BBC. 'Tube' and 'Econet' are registered trademarks of Acorn Computer PLC.

All rights reserved. No part of this Manual (except brief passages quoted for critical purposes) or of the computer programs to which it relates, may be reproduced or translated in any form or by any means, electronic, mechanical or otherwise, without the prior consent of the copyright owner.

Disclaimer: Because neither the BBC nor Acorn Computer PLC have any control over the circumstances of use of the programs, no warranty is given or should be implied as to the suitability of the programs described in this manual for any particular application. No liability can be accepted for any consequential loss or damage, however caused, arising as a result of the operation of the program.

©BBC Enterprises Limited 1986

First published 1986, revised reprint October 1986

Published by BBC Publications, a division of BBC Enterprises Limited.

35 Marylebone High Street, London W1M 4AA

Printed in the United Kingdom by Grange Press Ltd., London. ISBN 0 563 21310 8

Contents

	Introduction	6
1	Getting Started	7
1.1	The Components	7
1.2	Connecting up the Units	7
1.3	Tuning the Teletext Adaptor	9
2	The Teletext Terminal	11
2.1	Enter the Terminal	11
2.2	Leave the Terminal	11
2.3	Select a Page	12
2.4	Change Channel	12
2.5	Tune a Channel	13
2.6	Reveal and Conceal	13
2.7	Hold and Release a Page	13
2.8	Select a Sub-Page	13
2.9	Load a Page	14
2.10	Save a Page to File	14
2.11	Kept Pages	14
2.12	Terminal Status	15
2.13	Operating System Commands	15
2.14	Previous Page	15
2.15	Telesoftware	16
3	The Telesoftware Terminal	17
3.1	Introduction	17
3.2	Ordered and Disordered Files	17
3.3	Differences Related to Filing Systems	18
3.4	Downloading a File	18

4	Teletext Operating System Commands	21
4.1	Introduction	21
4.2	The Commands:	21
	*BBC	22
	*CH	22
	*DATA	23
	*DATE	23
	*DISPLAY	24
	*HOFF	24
	*HON	25
	*ITV	25
	* MAGAZINE	26
	*NOTTX	26
	*PAGE	27
	*S4C	27
	*TELESOFT	28
	*TELETEXT	28
	*TIME	29
	*TRANSFER	29
	*TTX	30
	*TUNE	30
5	Teletext OSWORD Commands	31
5.1	Introduction	31
5.2	The OSWORD Commands	32
6	Technical Information	41
6.1	The Teletext Data Format	41
6.2	The Catalogue File Format	43
6.3	The Teletext Character Set	45
6.4	The Teletext Control Codes	46
A	What is Teletext ?	49
B	Hints on Receiving Teletext	50
C	UK Network Identities	52

D	CP/M, PANOS, & DOS+ Telesoftware	53
E	The Copyright Position on Telesoftware	54
F	Fitting the Teletext ROM	55
G	Summary of Teletext OS Commands	59
H	Summary of Terminal Keys	60

IMPORTANT

IF YOU ARE RECEIVING TELETEXT ON AN ORDINARY TELEVISION RECEIVER YOU ARE COVERED BY YOUR EXISTING TELEVISION LICENCE, WHICH OF COURSE, MUST BE VALID. IF YOU DO NOT HAVE A TELEVISION RECEIVER BUT ARE RECEIVING TELETEXT WITH THE AID OF A VIDEO MONITOR UNIT, YOU MUST HAVE A COLOUR OR BLACK AND WHITE TELEVISION LICENCE DEPENDING ON WHETHER YOUR MONITOR IS COLOUR OR BLACK AND WHITE.

Introduction

This User Guide contains all the information you need to use the BBC Teletext Adaptor.

- Chapter 1 explains how to connect up the Teletext Adaptor and tune it in.
- Chapter 2 describes the facilities available with the Teletext Terminal.
- Chapter 3 describes how to download Telesoftware.
- Chapter 4 describes the extra Operating System commands that the Teletext ROM provides.
- Chapter 5 gives details of the OSWORD call used by the Teletext software.
- Chapter 6 gives detailed technical information on the data formats and the Teletext character set.
- Appendix A explains just what Teletext is.
- Appendix B gives hints and advice on Teletext reception.
- Appendix C is a table of Network Identity Codes for the United Kingdom.
- Appendix D explains about using PANOS, CP/M and DOS+ Telesoftware.
- Appendix E is a statement about copyright of BBC Telesoftware.
- Appendix F explains how to insert the Teletext ROM.
- Appendix G is a summary of the Operating System commands.
- Appendix H is a summary of the Terminal keys.

1 Getting Started

1.1 The Components

You should have :

- One Teletext ROM
- A function key strip
- This manual
- A BBC Microcomputer System Teletext Adaptor

You will not need a new aerial lead as the existing television aerial lead can be used.

The Teletext ROM will operate with any BBC model B, B+, or Master Microcomputer which uses Operating System version 1.2 or higher. If you are not sure which operating system your computer uses, switch it on, then type *FX0 and press **RETURN**.

You will see the letters OS plus a number. If this number is 1.20 or higher, you can go straight on to the next section. If you see:

OS0.10 or OS1.00

your operating system is unsuitable and to use Teletext you must fit a newer operating system ROM to your machine (your Acorn dealer will advise you on this).

1.2 Connecting up the Units

The first thing to do is to ensure that the Teletext ROM is installed correctly (see Appendix F).

Next, refer to Figure 1 which shows the microcomputer and Teletext Adaptor and connect up the system as follows:

1. Connect the 34-way plug on the Teletext Adaptor 'ribbon' cable to the the socket labelled '1MHz BUS' on the underside of the computer.

Caution: This plug may fit both ways round - the correct way is with the arrow at one end of the plug aligned with the arrow next to the '1MHz BUS' label. **IF THE PLUG WILL NOT FIT, EXAMINE THE SOCKET FOR DAMAGE AND OBSTRUCTIONS. DO NOT USE EXCESSIVE FORCE.**

2. Disconnect the aerial lead from the back of your television set and reconnect it to the standard television aerial socket on the back of the Teletext Adaptor.

Note: Indoor aerials don't generally provide a strong enough signal. You will in all probability need a loft or externally mounted aerial. If you don't think your aerial is good enough refer to Appendix B, or consult your TV dealer.

3. Place the key strip under the clear plastic trim at the top of the computer keyboard.
4. Switch on the Teletext Adaptor, then switch on the monitor, microcomputer and storage device (e.g. disc drive or cassette machine) if fitted. **IT IS IMPORTANT THAT THE TELETEXT ADAPTOR IS SWITCHED ON BEFORE THE MICROCOMPUTER**, otherwise you will have to press **BREAK** on your computer after switching on the Adaptor.

To check that all is well, type ***HELP** and then press **RETURN**.

A message similar to the following should be displayed :

ATS 2.50 (BBC1)

The **HELP** text for any other ROMs you have in your computer may also be displayed.

If the message 'No TTX Unit' appears, it means that the Teletext ROM cannot find the Teletext Adaptor, so check that the Adaptor is connected properly. If the message 'No Power' appears, check that the Adaptor is switched on and connected to the mains. The message 'No Signal' means that the Adaptor is not tuned in or the aerial is not connected.

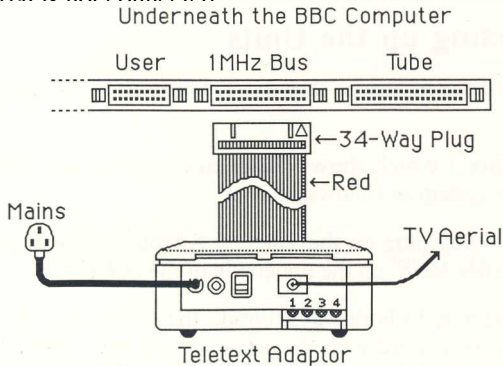

Figure 1 Connecting the Teletext Adaptor

1.3 Tuning the Teletext Adaptor

The Teletext Adaptor can be tuned to four separate channels, assigned numbers one to four. We recommend that you allocate these channels as :

- Channel 1 - BBC1
- Channel 2 - BBC2
- Channel 3 - ITV
- Channel 4 - Ch4 or S4C

If you tune the channels in a different order, the channel selection commands such as *BBC1 may not work properly.

The procedure for tuning in the system to receive each channel is as follows :

1. Type in *TELETEXT on the computer then press the **RETURN** key. The message 'BBC1' will appear in the top left of the screen.
2. Press the **SHIFT** key together with the red function key **f1** (BBC1) to select channel 1.
3. Press the **SHIFT** and **f0** (Tune) keys together.

Your screen will display a *station tuning scale* (see Figure 3). A bar indicates the strength of the Teletext signal received. Maximum signal strength is achieved when this bar is as long as the scale (100%).

4. Turn the number 1 tuning control on the rear of the Adaptor (Figure 2) to one end of its travel (this is indicated by a 'clicking' as you turn the control). *Now, very slowly* turn the control over its full travel. You will see the tuning bar suddenly increase in length as you tune into a BBC or IBA Teletext channel. This is accompanied by the channel and page numbers at the top of the screen. When you have found the longest tuning bar together with the messages CEEFAX and BBC1 you are correctly tuned into channel 1. (CEEFAX pages begin with 1 on BBC1, and 2 on BBC2.) **REMEMBER, YOU CAN RECEIVE ALL FOUR TELETEXT CHANNELS ON EACH TUNING CONTROL, SO MAKE SURE YOU GET THE RIGHT CHANNEL.**

5. Press the **SPACE-BAR** on your keyboard and repeat steps 2 to 4 for channels 2, 3, and 4. The only differences are:

In step 2, you should press the appropriate channel selection button, with **SHIFT**.

In step 4, you should rotate the appropriate tuning control (number 2, 3, or 4).

6. When you have tuned in all four channels, press the **SPACE-BAR**. This will remove the tuning scale and a Teletext index page will be automatically displayed. This is the index page for the channel you tuned last.

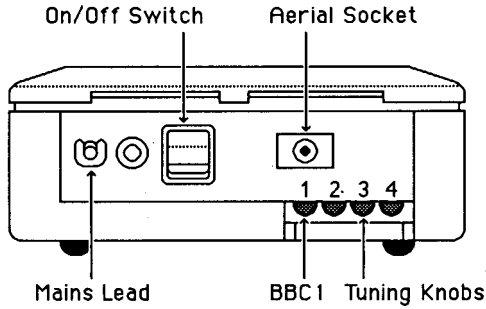

Figure 2 Rear view of the Teletext Adaptor

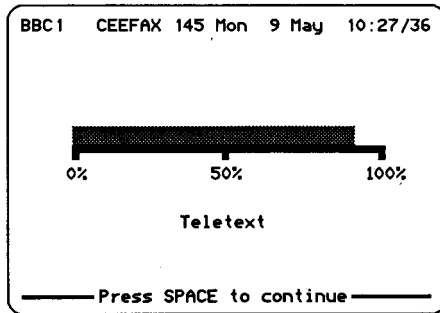

Figure 3 Tuning display

2 The Teletext Terminal

The Teletext Terminal behaves in the same way as the Teletext section of a television. However, it also has some extra facilities. Instead of using a remote keypad you use the BBC Microcomputer's keyboard and function keys. The function key strip should be placed above the red function keys when using the Terminal.

2.1 Enter the Terminal

To select the Teletext Terminal, type ***TELETEXT** and press **RETURN**. BBC1 CEEFAX is selected by default and the initial page is displayed once it has been received. This initial page is usually an index to the service.

At the top of the screen you will see a line of text which is constantly changing. This consists of :

- The channel title, or page number selected
- The name of the Teletext service (e.g. CEEFAX)
- The page number indicator, which displays the page number of the page presently being transmitted
- The date and time

2.2 Leave the Terminal

To leave the Terminal, press **f9**.

If you are using a co-processor (e.g. 6502 second processor, etc.), this will return you to the language or application that you called Teletext from. Normally, any programs, or data, will remain intact. If you are not using a co-processor, pressing **f9** will start BASIC; any programs, or data, will be lost.

The **BREAK** key

In order to work properly with different co-processors, the Terminal does not start up as a language if you are using a co-processor. This means that if you press **BREAK**, you will leave the Terminal and you will return to the previous language, or application. On systems without co-processors, pressing **BREAK** will re-initialise the Terminal, and clear any 'kept' pages (see Section 2.11).

2.3 Select a Page

To select a page, simply enter the page number using the number keys. The number you enter will appear at the top left of the screen, preceded by the letter 'P' for PAGE. If you make a typing error, or simply want to replace the last digit entered, press DELETE.

When all three page number digits have been entered, the Terminal will start looking for the page. The middle section of the top line will turn green to indicate that a page is being searched for. When the page is found, the Terminal displays it immediately and the top line of the screen turns white, signalling that the page has been found. The page number may also change colour. Red indicates that the page is corrupted or incomplete, and yellow means that the Terminal is unable to determine whether the page is alright or not.

Note that you can instruct the Terminal to look for a new page while it is still searching for the one you initially specified. It will automatically start looking for the new page when you enter the last digit.

At the bottom of the screen there may be a series of coloured boxes, followed by page numbers, or alternatively, a series of coloured 'keywords'. These correspond to the four coloured blocks on the keystrip (**f1** to **f4**). They show that the current page has 'links' to other pages. These links tell the Terminal that the pages specified are likely to be selected next, so it should capture them if they come by. This means that if you select one of these pages, either by entering its page number, or by pressing one of the coloured buttons, it will be displayed more quickly. If the bottom line contains coloured keywords, this means that the Teletext Editors controlling the broadcast have told the Terminal what sort of page the links point to.

Next to the four coloured keys you will find the INDEX button (**f0**). Normally, pressing this will take you back to the index page. This may be the main index page, or a sub-index, such as the sport index.

2.4 Change Channel

To change channel at any time, press one of the four function keys **f1** to **f4**, while holding down the **SHIFT** key. This will clear any kept pages and the Terminal will start to look for the initial page of the channel chosen.

2.5 Tune a Channel

Pressing **SHIFT** and **f0** will display the tuning bar and scale. See 'Tuning the Teletext Adaptor' (Section 1.3) for more details on tuning channels.

When you have finished tuning, press the **SPACE-BAR** to leave the tuning routine.

Note: The Adaptor will resist any attempt to retune a channel unless the system is in tuning mode.

2.6 Reveal and Conceal

Certain Teletext pages contain 'concealed' information. These include quizzes, jokes, etc. They usually contain a phrase such as :

Press **REVEAL** for the answers

To display the concealed information you should press **f6**. This will 'reveal' the information and put the page on 'hold' (see the following section). Press **f6** to conceal the information again and release the page.

2.7 Hold and Release a Page

Pressing the **f7** key will hold the currently displayed page and stop it from being updated by subsequent rolling pages. The clock display in the top right-hand corner will be replaced by the word 'HOLD'.

To release the page, and allow it to be updated, press **f7** again. The clock display should re-appear. The page is automatically released when a new page number is entered.

2.8 Select a Sub-Page

Some Teletext pages consist of more than one screenful of text. The individual pages are transmitted in sequence. A good example of this is *Newsreel* on BBC1. This consists of about a dozen 'sub-pages'. Each of these sub-pages has a number from one upwards. If you wish to select a particular sub-page, you should press **f8**. The clock display in the top right-hand corner of the screen will be replaced by an 'S' followed by four dashes. Any numbers you now type will replace the dashes in the same way as they do when entering a page number, except this time there are *four* digits to enter. **DELETE** works in the

same way as for page numbers. Leading zeros are important and must be entered; sub-page twelve, for example, would be entered as 0012, sub-page three would be entered as 0003, etc.

Once four digits have been entered, the Terminal will start searching for the sub-page specified.

To return to entering page numbers rather than sub-page numbers, press **f8** .

2.9 Load a Page

If you wish to display a Mode 7 screen stored on the current filing system (disc, network, etc.), press the **SHIFT** and **f6** keys. The message 'Load Page : ' is displayed, followed by a flashing line.

Type the filename of the screen you want to load, and press **RETURN**.

The screen is then displayed, along with the message 'Press SPACE to continue'.

When you press the **SPACE-BAR**, the top line starts to change again and the page displayed before you pressed **SHIFT f6** re-appears.

2.10 Save a Page to File

To save a page of Teletext to the currently selected filing system, such as disc or network, press the **SHIFT** and **f7** keys. The message 'Save Page : ' is displayed, followed by a flashing line.

Type in the filename for the page and press **RETURN**. (See the filing system's user guide for more information on filenames.)

The page is then stored in a file. If an error occurs when saving the page, a message is displayed.

When the page has been saved, the Terminal is ready for another command.

2.11 Kept Pages

If you are using Teletext for long periods at a time, you will find there are pages which you want to keep returning to, such as news and financial headlines, the sports results, or the weather. The Terminal has the ability to 'keep' some of these pages for you, updating them when it can, so that when you select them, they appear immediately, without your having to wait for them to

come round. The number of pages that can be kept in this manner is determined by the memory available in the computer. It ranges from about 7 to 11 pages.

To keep a page, select its page number in the usual way and press **COPY**. The message `Kept' will appear at the bottom of the screen and the computer will beep. You can now go and select another page to be kept, without having to wait for the previous page to be displayed. If you fill up all the available space for kept pages, the message `Buffer Full' will be displayed, and the page will not be kept.

To release a kept page, select its page number and press **COPY** again. The message `Released' will appear and the computer will beep.

To release all the kept pages, press **SHIFT** and **COPY** together. The message `All Released' will be displayed, and the computer will beep.

To see what pages have been kept, use the `Terminal Status' facility (Section 2.12).

2.12 Terminal Status

To see what pages the Terminal is currently looking for, together with any kept pages, press the **RETURN** key on its own. The screen will display a page showing the page numbers.

To return to the main Terminal mode, press the **SPACE-BAR**.

2.13 Operating System Commands

If you wish to perform an OS command, press the * on the keyboard and enter the command, followed by **RETURN**. The command will then be executed and the message 'Press **SPACE** to continue' will appear. If you wish to perform another OS command, press * again.

2.14 Previous Page

When you are looking at pages which have more than one sub-page, the page is often updated before you have had time to read it. To get round this problem, the Terminal has a `previous page' facility. Pressing **TAB** switches between the current page and the previous page, giving you more time to read the pages. If another new page arrives, it is automatically displayed and **TAB** then switches between it and the previous page.

2.15 Telesoftware

If you wish to download a Telesoftware file, you should first select the correct channel and then press f5. This starts the Telesoftware Terminal. For more information on how to use the Telesoftware Terminal, see the next chapter.

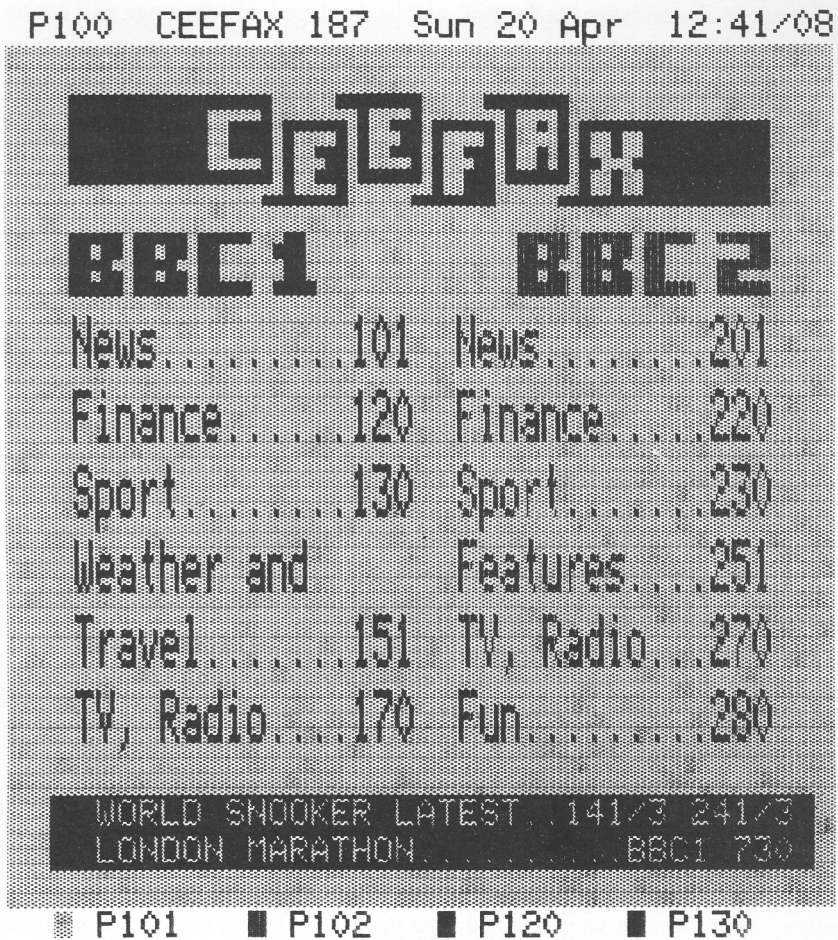

Figure 4 A Page from CEEFAX

3 The Telesoftware Terminal

3.1 Introduction

'Telesoftware' is the name given to any software that is distributed by electronic means, e.g. Teletext and Viewdata.

The Teletext Terminal has a built-in Telesoftware Terminal for downloading programs and data files onto your local filing system (e.g. disc or Econet). This makes the business of using Telesoftware very easy.

Telesoftware files are divided into sections, called 'blocks'. Each of these blocks occupies one sub-page of a Teletext page. Normally, a block contains about 800 bytes of information, encoded in a special format called 'Redefinable Telesoftware Format' (RTF). This format is very complex and it is beyond the scope of this manual to describe it.

3.2 Ordered and Disordered Files

There are two sorts of file in Telesoftware. One is the 'ordered' file and the other is a 'disordered' file.

Ordered files have to be downloaded in strict order, starting from block 1 of the file and carrying on until the end of the file. If an error occurs, in the fourth block of the file, for example, the Telesoftware Terminal has to wait for the fourth block to come round again before it can continue downloading the file. This makes ordered files very time-consuming to download, if you do not have a perfect signal from you aerial.

Disordered files can be downloaded in any order. Say the Telesoftware Terminal is downloading a file; it downloads the fourth and fifth blocks, but an error occurs in the sixth block. Well, it will skip the sixth block and download the seventh. It will carry on downloading blocks until the loading cycle comes round to the fourth block again. It will then wait for the sixth block, without doing any downloading, and attempts to download the block again. This ability to load the blocks in any order makes disordered files far more convenient. Most files on CEEFAX are disordered.

3.3 Differences Related to Filing Systems

The operation of the Telesoftware Terminal differs slightly if you are using the cassette filing system instead of disc or Econet.

Normally, when using disc or Econet, each block of a file is saved as it is received. This allows the Terminal to download larger files than would otherwise fit in memory.

Cassettes are not fast enough to save each block as it is received, so if you are using cassettes to store files, rather than discs or Econet, blocks have to be stored in memory until the whole file has been received. This means that cassette users cannot download some of the very large files available on Telesoftware.

3.4 Downloading a File

On Teletext services that carry Telesoftware there is a special page called the 'catalogue'. This page contains a Telesoftware file which has details of all the programs currently available on the service. The actual position of this page is not defined, but the Telesoftware Terminal can find it by using a 'link' from the index page.

To download a file, follow this procedure :

1. Enter the Teletext Terminal.
2. If you are using discs you should place a disc with sufficient room to store the programs in the drive. ADFS users must use a *MOUNT command to inform the computer that they have changed discs.
3. Press **f5** (Telesoftware).

The computer will now look for the catalogue of Telesoftware. If there is no catalogue, an error message will be displayed. It may take the computer several seconds to find the catalogue so please be patient.

Once the catalogue has been found, the first few entries are displayed on the screen. Only those entries that say they are suitable for the BBC Microcomputer will be displayed.

4. Scroll through the list using the **UP** and **DOWN** cursor keys to move the coloured bar.
5. When you have found the program or file you want to download, press the **RETURN** key.

Some of the entries may be in colour. If the item above or below an entry is in the same colour, this indicates that the files go together and both should be downloaded. There may of course be more than two files in a group.

When you have selected the file you want to download and pressed **RETURN**, the screen will clear and the name of the file, along with its load and execution addresses, will be displayed.

The computer now waits for the page containing the file to arrive.

When it finds the file, a display of all the blocks in the file appears - this is initially in white. As each page of a file is found, the appropriate block turns green, unless an error is detected, in which case the block turns red. If there are more than eighty blocks, a text message is displayed instead.

When all the blocks are green, the complete file has been downloaded. If you are using a cassette system, the Terminal will now save the file, so place a cassette in the recorder and follow the standard SAVE instructions.

Once the file has been saved, the Telesoftware Terminal will again look for the catalogue and display it. If you have finished downloading Telesoftware, press **ESCAPE** to return to the main Terminal.

If, while you are downloading a file, the message 'Different File' appears, the Terminal has encountered another file on the same page. It is quite possible to put several files on one page and thereby reduce the amount of space taken up on the normal Teletext service.

If you are downloading a group of related files, you should start by downloading the first file, and carry on downloading each file in turn until all of them have been downloaded. Occasionally a special 'loader' will be supplied to download a group of files. If this is the case it will be the first file in the group and have the word 'Loader' beside it. Download the loader in the normal way, return to BASIC, and *RUN the loader.

Hint for Disc Users: If you are going to download a large Telesoftware file, it is a good idea to COMPACT the disc before you start to make sure there is sufficient room on your disc. (See the Disc System User Guide for information on compacting discs.) As the Terminal uses OPENOUT, the filing system will need at least 16K free to open any Telesoftware file.

CEEFAX 138 Sun 23 Feb 18:31/18

TeleSoftware Terminal

Mandel	BBC BASIC	35	Pages
ManNote	Text	4	Pages
Exam1	BBC BASIC	12	Pages
Exam2	BBC BASIC	5	Pages
Exam3	M/C	1	Page
Books	BBC BASIC	77	Pages
Notes	Text	8	Pages
MLive	Text	6	Pages
NIM	Pascal	11	Pages

See Page 702 for more details.

Use the UP & DOWN cursor keys to select a file, and press RETURN to download..
 Press ESCAPE to exit.

Figure 5 The File Selection Screen

CEEFAX 705 Sun 23 Feb 18:30/41

Filename : MANDEL

Load : &FFFF1900 Exec : &FFFF8023

24 out of 35 block(s) received.

Not Received
 Ok
 Error - Retry

↑

This program will take about 12 minutes to download, so please be patient.

Figure 6 The File Downloading Screen

4 Teletext Operating System Commands

4.1 Introduction

This chapter is only of interest if you intend to write your own programs to handle Teletext data.

The Teletext Operating System (OS) commands allow you access to the facilities of Teletext from your own programs. Some of the commands should be used with care because they copy Teletext data into the computer's memory and if used incorrectly could corrupt your program. Certain of the Terminal's facilities, such as REVEAL, are not available as OS commands. These have to be implemented by your program if you wish to use them.

Important: Before you use the Teletext OS commands you must issue a *TTXON command (see below) to tell the Teletext Adaptor to start accepting Teletext data. When you have finished with Teletext, issue a *TTXOFF command to turn off the Adaptor's Teletext reception. This is important, as the computer's memory may be corrupted by unexpected data arriving from the Adaptor.

4.2 The Commands

All the commands can be typed in from the keyboard or included in a BASIC program. Each command is described separately under the following headings:

Description	What the command does in functional terms.
Syntax	The actual command words and the order in which commands and data are arranged.
Example	An example of a string of commands including the one described.
Note	Additional information.

As with any other BBC Microcomputer OS command, Teletext allows you to type abbreviations for its commands, such as *TE. for *TELETEXT, or *MAG. for *MAGAZINE.

To avoid clashes of OS command names, the Teletext system allows an extra 'T' to be placed before a command, e.g. *TTIME for *TIME, or *TPAGE for *PAGE.

***BBC**

Description

This command is used to select channels 1,2,3 or 4 for Teletext reception.

Syntax

*BBC <channel>

where <channel> is 1,2,3 or 4. If no channel is specified, 1 is assumed.

Example

*TTXON

*BBC1

This will select channel 1.

Notes

It is up to you to ensure that channel 1 is tuned to BBC1 and channel 2 is tuned to BBC2 for this command to produce the expected results.

***CH**

Description

This command is identical to *BBC and is for use in countries other than the UK. It can also be used to select Channel 4.

Syntax

*CH <channel>

where <channel> is 1,2,3 or 4. If no channel is specified, channel 1 is assumed.

Example

*TTXON

*CH4

This will select Channel 4 for Teletext reception.

***DATA**

Description

This command transfers the full data for the current page to a given memory location. For details of the data format, see Chapter 6.

Syntax

*DATA <address>

where <address> is an area of memory reserved for the data. The memory of the current language processor is used, unless an address in the form FFFFxxxx is used.

Example

```
*TTXON
*S4C
*PAGE 400
OSCLI("DATA"+STR$~(Buffer))
```

Notes

This command will wait forever if the current page cannot be found. **ESCAPE** will exit the command if **ESCAPE** is enabled.

The area of memory reserved for the data must be 2K long, i.e. 2048 bytes.

***DATE**

Description

This command causes the date, as transmitted in the television data packet to be displayed.

Syntax

*DATE

Example

```
*TTXON
*BBC1
*DATE
```

Notes

In order to give the Adaptor time to grab the date, which is only transmitted once a second, you must leave a gap of at least 1.5 seconds between changing channel and asking for the date.

If the Television Service Data Packet (TSDP) is not transmitted, an error message is displayed instead of the date.

***DISPLAY**

Description

This command is used to display any Teletext page which has previously been transferred into memory with a *TRANSFER command. It decodes the page from the internal form used by the Teletext system into the form required for screen display. The computer must be in Mode 7 or 135 (shadow) for this command to work properly.

Syntax

*DISPLAY <address>

where <address> is the hexadecimal address used in the *TRANSFER or *DATA commands. If the address is eight digits long and the first four are 'FFFF', the memory used will be that of the I/O processor, regardless of whether a co-processor is attached or not.

Example

```
MODE 7
*TTXON
*BBC2
*PAGE 200
*TRANSFER 7000
*DISPLAY 7000
```

This will display BBC2 CEEFAX page 200 on the screen.

***HOFF**

Description

This command switches off the top line display (Header) of the Teletext system.

Syntax

*HOFF

***HON**

Description

This command controls the top line display (Header) of the Teletext system. It allows the top line to be displayed, with or without the clock. It also sets the display to any magazine (see *MAGAZINE).

Syntax

*HON [0] Switch on the Header line with the clock display.
*HON 1 Switch on the Header line without the clock display.

The square brackets mean that the zero is optional.

Example

```
*TTXON  
*BBC1  
*HON 1  
PRINT TAB(32,0);CHR$(130);"HOLD";
```

This will switch on the Header for BBC1, and print the word 'HOLD' where the clock display normally goes.

Notes

This command only works if the screen display is currently Mode 7 (without shadow) and the screen has not been scrolled since the last CLS. Scrolling within a window does not matter. The Headers of certain services appear to flicker; to stop the flicker, use the *MAGAZINE command.

***ITV**

Description

This command selects channel 3 or 4 for Teletext reception. If no number is given after the command, channel 3 is used.

Syntax

```
*ITV  
*ITV 1  
*ITV2
```

Example

```
*TTXON  
*ITV  
*PAGE 100
```

This will make page 100 of ORACLE the currently selected page.

***MAGAZINE**

Description

This command controls which magazine's Headers are displayed.

In Teletext, the pages are grouped together in 'magazines'. These consist of up to 100 pages. The initial page digit signifies which magazine the page is in; 103,156, and 175 are all in Magazine 1, and 704 is in Magazine 7, etc.

There are two ways of transmitting Magazines in Teletext. In one the magazines are sent in numeric order, e.g. Magazine 1, Magazine 2, etc. This is called 'serial' transmission. In this case, all the Headers for all the magazines are displayed and the *MAGAZINE command has no effect. The other method is to send the magazines in 'parallel'. An example page sequence might be 100, 200,101,201,102,202,etc. In this case the Headers appear to flicker.

Syntax

*MAGAZINE <mag>

where <mag> is the first digit of the page numbers to be displayed.

Example

*TTXON

*ITV

*HON

*MAGAZINE 1

This will display only those Headers whose page number begins with 1.

***NOTTX**

Description

This command 'removes' the Teletext ROM from the Operating System's view. It produces the message 'Press CTRL-BREAK...'. Once 'removed' in this way, Teletext no longer takes up any of the computer's memory and the Teletext commands become inoperative. The only way to 'replace' the ROM is to switch the computer off and on again.

A less drastic, but non-software method of switching off the Teletext system is to switch off the Adaptor, and press **BREAK** on the computer keyboard. The Teletext system can then be switched on again by switching on the Adaptor and pressing **BREAK**.

Syntax

*NOTTX

Notes

Switching the Teletext system on and off will alter PAGE in a Model B or B+ computer. You should therefore save any programs you are working on before issuing this command. This is NOT the case with *TTX.

***PAGE**

Description

This command sets the specified Teletext page as the current page.

Syntax

*PAGE <page number> [S<sub-page number>]

The part within square brackets is optional. The page number must be 3 digits long, and the sub-page number four digits long.

Example

*TTXON

*PAGE 119S0002

This selects the second sub-page of page 119, channel 1.

Note

This command has nothing to do with the BASIC PAGE command.

***S4C**

Description

This command selects channel 4 for Teletext reception. It is up to you to ensure that channel 4 is tuned to S4C for this command to have the expected results.

Syntax

*S4C

Example

*TTXON

*S4C

Dewiswch Sianel Pedwar Cymru.

***TELESOFT**

Description

This command provides a degree of compatability with the old TFS. When issued it has the same effect as a *TTXON command, except when *TRANSFER or *DISPLAY is used. When in TFS emulation mode *TRANSFER returns the teletext data in the form of a 960 byte block, consisting of 24 rows of 40 characters each. The data has the top bit set on every character, and is suitable for immediate display. This means that *TRANSFER 7C00 will produce the correct screen display.

Syntax

*TELESOFT

Example

```
*TELESOFT
*TRANSFER FFFF7C00
*SAVE MODE7 FFFF7C00+400
```

This will save a file called MODE7 which will be a normal MODE 7 screen.

Notes

If you are going to use some of the more advanced features of the ATS, which are not available in the old TFS, there is no point in using this command as the programs will not work with TFS anyway. Use *TTXON instead and make use of the more powerful data format.

***TELETEXT**

Description

This command starts the Teletext Terminal. If a co-processor is in use, the Terminal is started as an OS command and is exited if BREAK is pressed. Otherwise, the Terminal is started as a normal language.

Syntax

*TELETEXT

TIME*Description**

This command displays the local time, as transmitted by the Television Service Data Packet.

Syntax

*TIME

Example

*TTXON

*BBC1

*TIME

Notes

Time information is extracted from the television service data packet (TSDP). If the TSDP is not transmitted, an error message is displayed instead of the time.

TRANSFER*Description**

This command transfers the display data, for the current page to a given memory location. For details of the data format, see Chapter 6.

Syntax

*TRANSFER <address>

where <address> is an area of memory reserved for the data. The memory of the current language processor will be used unless an address in the form FFFFxxxx is used.

Example

*TTXON

*BBC1

*PAGE 700

*TRANSFER 7000

Notes

This command will wait indefinitely if the current page cannot be found. **ESCAPE** will exit the command if **ESCAPE** is enabled.

The area of memory reserved for the data must be at least 1K long, i.e. 1024 bytes.

***TTX**

Description

This command controls the Teletext Adaptor. If you wish to use Teletext, you must first issue a *TTXON command. When you have finished, you should issue a *TTXOFF command to switch off the Teletext Adaptor.

Syntax

*TTXON
*TTXOFF

Example

*TTXON
*TIME

Notes

The *TTXON and *TTXOFF commands are not necessary if you are using the Teletext Terminal, which automatically switches the Adaptor on and off.

***TUNE**

Description

This command invokes the tuning routine for the currently selected channel. For more details see Section 1.3.

Syntax

*TUNE

5 Teletext OSWORD Calls

5.1 Introduction

Teletext OSWORD calls allow you access to the facilities of Teletext from your own assembly language programs, and to access some of the lower level facilities available with the Teletext system.

The basis of the Teletext system is the 'page grabber'. This is a piece of machine code which constantly looks for Teletext pages. It can look for up to 20 pages, automatically storing them in the designated area of memory when it finds them. It also looks for, and stores, the TSDP. The Teletext OS commands only use one of the page grabber's 20 records to grab pages requested with *PAGE. From assembly language however it is possible to use all 20, as the Terminal does.

All the facilities of the Teletext system are controlled by one OSWORD call &7A. The first byte of the parameter block for an OSWORD &7A is a command code. The commands are described in Section 5.2.

Teletext System Control

OSWORD with A = &7A

The call address is &FFF1

On entry, X (lo-byte) and Y (hi-byte) point to the parameter block:

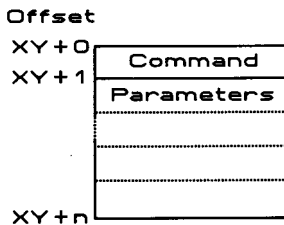

Important: Before you use the Teletext OSWORD call, you must issue a *TTXON command, or an OSWORD &7A with command = 13, to tell the Teletext Adaptor to start accepting Teletext data. When you have finished with Teletext, issue a *TTXOFF command, or OSWORD &7A with command = 12, and command = 14, to switch off the Adaptor's Teletext reception.

5.2 The OSWORD Commands

For each call a list of parameters is given, along with the offset within the parameter block at which they reside.

0 Read Channel

Read the channel which is currently being used for Teletext reception.

Parameters:

- 0 0
- 1 Returned channel number (0 to 3 ; 0: BBC1)

1 Set Channel

Set the channel to be used for Teletext reception.

Parameters:

- 0 1
- 1 The channel to be used (0 to 3).

2 Read a Record Flag

For each record in the page grabber there is an associated *flag byte*. This contains information such as whether the page has arrived yet, and if it is being updated at the moment. It also controls whether the page is on hold or not. The format of the flag is :

Bit 0	HOLD	(0: No, 1: Yes)
Bit 1	Page received	(0: No, 1: Yes)
Bit 2	Page being updated	(0: No, 1: Yes)

Other bits undefined.

Parameters:

- 0 2
- 1 Record number (0 to 19)
- 2 Flag for record requested
- 3 Record currently being grabbed (or &FF if none)

3 Set a Record Flag

This command allows you to alter the flag for a particular record. This is done to HOLD or RELEASE a page and also to clear the 'page received' bit so that a new copy of the page can be detected.

Parameters:

- 0 3
- 1 Record number (0 to 19)
- 2 New value for flag

4 Read a Page Grabber Record

This command returns one of the page grabber's records.

Parameters:

- 0 4
- 1 Record number (0 to 19)
- 2 Magazine number of page being looked for
- 3 Page number of page (in BCD, i.e. &23 means page 23)
- 4 Sub-page number (hi-byte) &3F means any sub-page
- 5 Sub-page number (lo-byte) &7F means any sub-page
- 6 Address to put page (lo-byte)
- 7 Address to put page (hi-byte)

Note: The address is always in the I/O processor

5 Set a Page Grabber Record

This command allows you to specify which page should be grabbed by a particular record. If you specify the same page in different records, only the first record will ever get it.

Note: The page grabber always stores pages in the I/O processor memory. If you wish to store the pages in the co-processor, you must use the Teletext OS commands which will copy them across for you.

Parameters:

- 0 5
- 1 Record number (0 to 19)
- 2 Magazine number of page to be looked for
- 3 Page number of page (in BCD, i.e. &23 means page 23)
- 4 Sub-page number (hi-byte) &3F means any sub-page
- 5 Sub-page number (lo-byte) &7F means any sub-page
- 6 Address to put page data (lo-byte)
- 7 Address to put page data (hi-byte)

6 Read the No. of Rows to be Captured

This command returns the number of rows that are being grabbed for each page.

Parameters:

- 0 6
- 1 Number of rows being grabbed

7 Set the No. of Rows to be Captured

This command allows you to specify the number of rows that are stored for each page. If you only want to store the displayed part of a page, set the number of rows to 24. This will require 1024 bytes of memory per page. If you want to store non-display rows in addition to display rows, you should set the number of rows to 30. This will require 1260 bytes per page.

Parameters:

- 0 7
- 1 Number of rows

8 Read the Header Line Status

This command returns the current status of the Header line.

Parameters:

- 0 8
- 1 Header status

Status values are :

&00	Header off
&01	Header on with clock
&FF	Header on without clock.

9 Set the Header Line Status

This command sets the current status of the Header line (*HON).

Parameters:

0	9
0	Header status

See the previous call for the status values.

10 Read the Magazine for Header Display

This command returns the magazine whose Headers are currently displayed.

Parameters:

0	10
1	Magazine

Note: Magazine 8 is returned as zero. &FF means that all Headers are displayed.

11 Set the Magazine for Header Display

This command sets the magazine whose Headers are to be displayed (*MAGAZINE).

Parameters:

0	11
1	Magazine

Note: Magazine 8 should be entered as zero. &FF means that all Headers are to be displayed.

12 Switch Off Teletext Interrupts

This command disables the Teletext Adaptor interrupts (*TTXOFF).

Parameter:

0 12

13 Switch On Teletext Interrupts

This command enables the Teletext Adaptor interrupts (*TTXON).

Parameter:

0 13

14 Clear All Page Grabber Records

This command clears all page grabber records. It should be issued before turning off Teletext interrupts if you are not going to re-enable them soon.

Parameter:

0 14

15 Read Television Service Data Packet

This command returns the TSDP, except for the 'status message' (which is not connected with Teletext).

Parameters:

0 15
1 TSDP
to
13

The Television Service Data Packet:

Byte	Meaning
1	Magazine for initial page
2	Page number for initial page (&FF : Not Specified)
3	Page sub-code for initial page (hi-byte)
4	Page sub-code for initial page (lo-byte)
5	Network Identity Group (hi-byte)
6	Network Identity Group (lo-byte)

7	Time offset from Universal Co-ordinated Time (UTC)	
8	Modified Julian Date	(10,000's) (BCD)
9		(1000's and 100's) (BCD)
10		(10's and 1's) (BCD)
11	Universal Co-ord. Time (Hours)	(BCD)
12		(Minutes) (BCD)
13		(Seconds) (BCD)

The Network Identity Group is a 16 bit number, unique to each television channel. A list of the numbers used in the UK is given in Appendix C. You will see that each IBA company has its own identity number.

The time offset allows the local time to be calculated from UTC. In the UK therefore, the time offset is normally &81, but in British Summer Time it becomes &85 to indicate that one hour should be added to UTC. Note that UTC is the international name for Greenwich Mean Time (GMT).

The format of the offset is as follows:

Bit	Meaning
0	Always 1
1	Half-hour
2	1 Hour
3	2 Hours
4	4 Hours
5	8 Hours
6	0: Add offset, 1: Subtract offset
7	Always 1

16 Clear Page Grabber Status

This command halts the page grabber, even if it is half way through grabbing a page. If you wish to change a record it is advisable to check if it is currently being updated. If so, call this command to stop the update before changing the record.

Parameter:

0 16

17 Read Teletext Adaptor Status

This command returns the status of the Teletext Adaptor.

Parameters:

- 0 17
- 1 Adaptor status

Status: &00: On and connected
 &01: On, but no TV signal
 &02: Off, but connected
 &FF: No Adaptor connected

18 Set the Subtitle Enable Flag

This command allows you to turn subtitle reception on and off. Subtitles are NOT stored, but displayed immediately upon reception. This allows them to remain synchronised with the TV program.

Parameters:

- 0 18
- 1 Subtitle enable (&00: enable, &FF: disable)
- 2 Subtitle magazine (normally 0)
- 3 Subtitle page (normally &88)

19 Set Interrupt Handling Flag

This command allows you to control whether the Teletext ROM handles the interrupts from the Adaptor, or whether they are passed on to other software. This can be used to allow very low level control of the Teletext Adaptor.

Parameters:

- 0 19
- 1 Interrupt enable (&00:enable, &FF: disable)

20 Tuning Routine

This command calls the tuning routine for the current channel. The call is terminated by pressing the **SPACE-BAR**.

Parameter:

- 0 20

21 Return Time from TSDP

This command returns the local time in ASCII form.

Parameters:

- 0 21
- 1 'HH:MM:SS' time string
- 10 Error flag (&00: time OK, &FF: time not found)

22 Return Date from TSDP

This command returns the local date in ASCII form.

Parameters:

- 0 22
- 1 DD/MM/YYYY' date string
- 12 Error flag (&00: date OK, &FF: date not found)

23 Check CRC

This command checks the CRC of the page pointed to. It allows you to check that the data collected by the Teletext Adaptor has not been corrupted. This could be very important if the data being collected is of a financial nature.

Parameters:

- 0 23
- 1 Pointer to page data (lo-byte)
- 2 Pointer to page data (hi-byte)
- 3 Returned flag (0: No CRC, 1: CRC OK, &FF: CRC Failed)

Note: The page data must be in the I/O processor.

24 Download a File from Teletext

This command downloads a file from the current channel.

Parameters:

0	24	
1	Pointer to filename	(lo-byte) (terminated by &OD)
2	Pointer to filename	(hi-byte)
3	Load address	(lo-byte) (32 bits)
:		
6	Load address	(hi-byte)
7	Exec address	(lo-byte) (32 bits)
:		
10	Exec address	(hi-byte)
11	Magazine number	(0 to 7)
12	Page number	(&00 to &FF)
13	Load to memory/file	(&00: memory, &01: file)
14	Reset default tables	(&00: yes, &01: no)

Notes: The filename must be in the I/O processor and be in upper case only. The load address must agree with the load address in the file being downloaded. This is normally held in Block 1 of a file, or is available from the catalogue file (see Chapters 3 and 6).

When downloading to memory, the file is always stored at OSHWM onwards, regardless of the load address. When downloading to file, the load and exec addresses are set to those given in the telesoftware file.

Normally, the default tables **SHOULD** be reset.

The progress of downloading is shown by a graphical display representing the blocks received.

25 De-Ham a Byte

This command will translate an 8 bit hammed byte into a 4 bit decoded value.

Parameters:

0	25	
1	Byte to be decoded	
2	Decoded byte (&FF: unrecoverable error)	

Note: If bit 6 is set, but bit 7 is not, then an error occurred in the transmission, but was recoverable, thanks to the hamming protection. The value returned should normally be ANDed with &OF before being used.

6 Technical Information

6.1 The Teletext Data Format

Each row of Teletext data (normally equivalent to a single row of the screen display) takes up 42 bytes. The first byte contains the magazine number of the page, and the second byte is a 'row address'. The row address is a number between 0 and 29. The first row is always row address 0. The following rows can be in ANY order. The maximum number of rows captured is controlled by OSWORD &7A:7. For *TRANSFER, 24 rows are captured, and for *DATA, 48 rows. Unused rows have both the magazine and row address set to zero.

Row 0 is the Header row and contains the full information on the Teletext page. The first byte after the two initial bytes is the page number. This is a hexadecimal number, so page 119 would have a page number &19. The next two bytes are the sub-page number, high byte first. If this is &0000 there is only one sub-page, otherwise it is the number of the rolling page received. The next two bytes contain the control bits for the page (see later).

The next three bytes are all zero and have no meaning. Finally, there are 32 bytes which are suitable for display and contain the displayed part of the Header, complete with the clock display. Each byte should be OR'ed with &80 before being displayed.

The following diagram shows the general format of the data, and the specific formats for rows 0 and 27 :

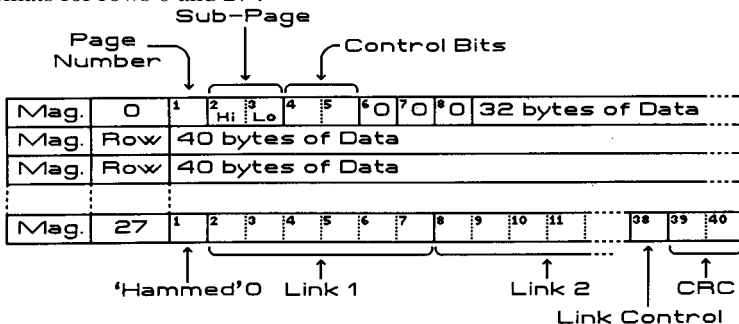

The control bits contain information such as whether the Page Header should be displayed, whether the page a newsflash, etc. The meaning of each bit is given below:

Byte 4		Byte 5	
Bit 0	Unused	Bit 0	Suppress Header
1	Unused	1	Update Indicator
2	Unused	2	Out of Sequence
3	Erase Page	3	Inhibit Display
4	News Flash	4	Serial Magazine
5	Sub-Title	5	Unused
6	Unused	6	Unused
7	Unused	7	Unused

Rows 1 to 24 are suitable for display, except that each of the next 40 bytes should be OR'ed with &80 before being displayed. Not all the Rows 1 to 24 need necessarily be present and those that are not should be assumed to contain 40 spaces.

Row 25 is not intended for display, but may contain 40 bytes of encoded tele-software.

Row 27 contains the links to other pages and the Cyclic Redundancy Check (CRC). There can be up to four row 27s and they are distinguished by the first of the 40 data bytes. Once this byte has been de-hammed (see OSWORD &7A: 25) it contains a value of 0 to 3. Only row 27/0 contains the CRC. Bytes 2 to 37 of the data contain six links, each six bytes long. These six bytes must be de-hammed before use. The format of a link group is given below :

De-Hammed Bytes i.e. Only 4 bits long					
0	1	2	3	4	5
Page Number			Page Sub-Code		
Digit 2	Digit 1	Digit 4	Digit 3	Digit 2	Digit 1
			C3		C5C4

Example	0	1	0	1	0	0	1	0	0	1	1	0	0	0	0	1	0	0	0	0	0	0	0	0	0	0	0	0	0
	5			2			6			1			0			0													
	Page 25s0016 of current magazine																												

The three bits, C3 (bit 3 of the fifth byte), C4, and C5 (bits 2 and 3, respectively, of the sixth byte) form a 3 bit number (C3 is the least significant bit of this number). This three bit number is EOR'ed with the magazine number of the current page to get the magazine number of the page pointed to by the link. Sub-code &3F7F indicates that the sub-code does not matter. Page number &FF means that the link is not being used.

The 38th byte of the data contains the Link Control. This byte must be de-hammed to give a four bits. The meaning of these bits is given below:

Bit 0	Bit 1		Bit 2	
0	0	Not Chained	0	Computer Readable
1	0	Start of Chain	1	For Display
0	1	End of Chain	Bit 3	
1	1	Within Chain	0	Level 1 Teletext Row 24 not shown
			1	FLOF Teletext Row 24 is shown

The 39th and 40th bytes contain the 16 bit CRC. The algorithm used to calculate CRC's is too complex to discuss here. Use OSWORD &7A:23 to check the CRC of any Teletext data.

Rows 26, 28 and 29 are not transmitted in Level 1 Teletext.

6.2 The Catalogue File Format

The catalogue file contains a list of all the programs and files currently available on the telesoftware service of the selected channel. The format is as follows :

The file begins with two strings, each intended for direct display and containing teletext colour codes. Each byte must be OR'ed with &80 before being displayed. The first byte of any string in the catalogue contains its length (not including the length byte itself). There then follow *n* entries, one for each file. Each entry consists of eight fields.

Field one refers to the type of computer that the file is intended for and is a string. The computer types defined so far are :

- ANY : Any computer
- AMIGA : Commodore Amiga computers
- AMSTRAD : Amstrad computers
- ATARIST : Atari ST computers
- BBC : BBC Microcomputer System (B, B+, Master)
- CBM64 : Commodore 64 computers
- CBM128 : Commodore 128 computers
- CPM : Any CPM computer
- IBM : IBM Computers
- MSDOS : Any MSDOS computer
- SPECTRUM : Sinclair Spectrum computers
- *** : End of catalogue - no more data

Field two is the filename, as a string, plus a single colour-code at the beginning of the filename. This colour-code is NOT part of the filename and is for display purposes only.

Field three is a string, defining the type of file. This is completely free-format, but some examples of entries that might be included are given below :

TEXT	:	Text only files (ASCII)
BASIC	:	A BASIC program (tokenised if necessary)
EXEC	:	An EXEC file, possibly a BASIC program in text form
M/C	:	Machine Code
SCREEN	:	Screen picture
LOADER	:	Multiple file downloader (always M/C for BBC)
FORTTRAN	:	Fortran source code
PASCAL	:	Pascal source code

Field four is a string, giving the size of the file. This is also completely free-format, but some examples of possible entries are given below :

12 Pages
&3453 Bytes
8K

Field five is the LOAD address of the file and is four bytes long (32 bits), with the most significant byte first (unlike 6502 format).

Field six is the EXEC address of the file and is four bytes long, with the most significant byte first.

Field seven is the magazine in which the file can be found. This is a single byte with values from 0 to 7.

Field eight is the page number on which the file can be found. This is a single byte with values from 0 to 255.

6.3 The Teletext. Character Set

Here is the Teletext Character set for the BBC Microcomputer. Note that it starts at &80 (128), NOT at &00. The characters in columns &CO, and &DO are always shown, regardless of whether they are preceded by a graphic colour or not.

HEX	80	90	A0	B0	CO	DO	E0	FO
0					@	P	-	p
1	Red Alpha	Red Graphics	!	1	A	Q	a	q
2	Green Alpha	Green Graphics	"	2	B	R	b	r
3	Yellow Alpha	Yellow Graphics	£	3	C	S	c	s
4	Blue Alpha	Blue Graphics	\$	4	D	T	d	t
5	Magenta Alpha	Magenta Graphics	%	5	E	U	e	u
6	Cyan Alpha	Cyan Graphics	&	6	F	V	f	v
7	White Alpha *	White Graphics	'	7	G	W	g	w
8	Flash	Conceal Display	<	8	H	X	h	x
9	Steady *	Contiguous* Graphics)	9	I	Y	i	y
A	End Box †	Separated Graphics	*	:	J	Z	j	z
B	Start Box †		+	;	K	←	k	↳
C	Normal Height *	Black Background *	,	<	L	↳	l	
D	Double Height	New Background	-	=	M	→	m	¼
E		Hold Graphics	.	>	N	↑	n	÷
F		Release Graphics *	/	?	O	#	o	■

* These control characters are presumed before each screen row begins.

† These control characters have no action on the BBC Microcomputer but may be contained in some Teletext pages.

6.4 The Teletext Control Codes

The previous table shows the available characters, their codes and also the control codes. The control codes can be sent in place of any character code anywhere in a row. The control codes are normally displayed as spaces (but see the section below on the hold graphics control). The fact that they can be used within a row enables you to change some aspects of the display part way through a row (e.g. the display colour).

Display Modes

There are three modes of display in the Teletext system - one alphanumeric mode and two graphics modes. The two graphic modes are called contiguous and separated. The difference is best shown by illustration :

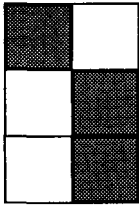

Contiguous

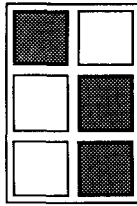

Separated

Colour

Seven different display colours are provided (red, green, yellow, blue, magenta, cyan, and white). Fourteen control codes are available to select alphanumerics or graphics and the required colour simultaneously. This provides a change of colour and mode in one step.

The background colour can be any of the seven colours listed above, or black. Coloured background is selected by using the 'new background' control code. After this code appears, the new background colour will be the display colour in use when the 'new background' control was used.

Flashing and Concealed Characters

Two modes are provided in which the display characters appear as spaces some of the time. In flashing mode, a character appears alternately as a space and as the character at a rate determined by a clock in the computer. In conceal mode, the character appears as a space until revealed. The character is revealed by pressing 'Reveal' (f6 on the BBC Microcomputer).

Double Height

Characters may be displayed in double height, in which case they take two rows. Therefore the information sent in row n also applies to row n+1 in this mode. The decoder ignores row n+1 if it is sent. It is possible to mix single and double height characters, but single height characters can only appear on the top line of the two.

Hold Graphics Control

The hold graphics control code allows a limited number of abrupt display colour changes. A control code is normally displayed as a space which therefore causes a break in the display. In hold graphics mode, the character rectangle occupied by the control code is filled with a held graphics character. This can be used with any control code issued in the graphics mode. The held graphics character will be the most recent character with bit 6 equal to 1 in its code, provided that there has been no intervening change in either the alphanumeric/graphics modes or the normal/double height modes. In the absence of a suitable character, a space is displayed.

P284 CEEFAX 267 Sun 20 Apr 13:13/01

I'm going to make a vegetable stew,
Sheila Starfish told Reg - SEE IF
THERE ARE ANY CARROTS IN THE PACKET!

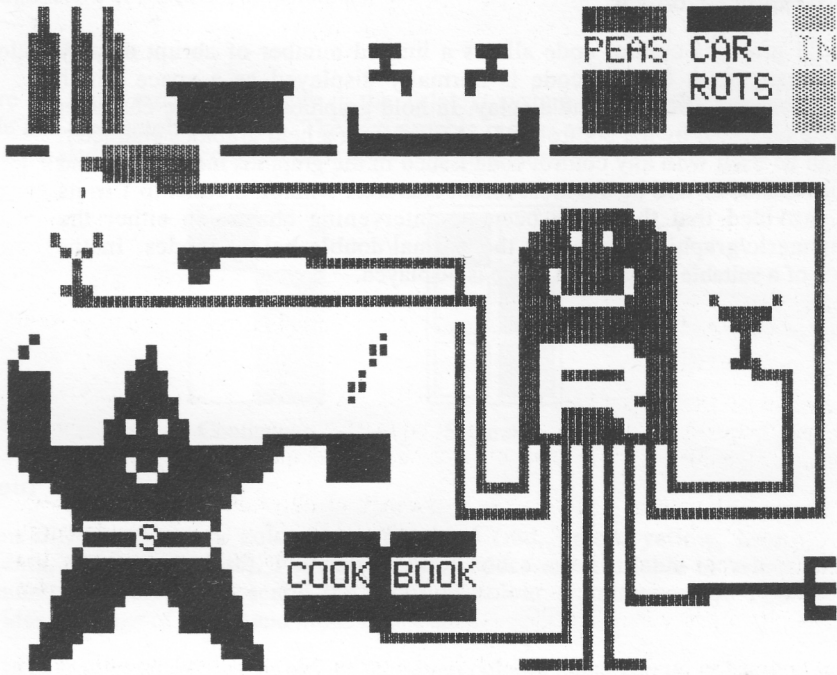

Figure 8 A Page from CEEFAX

A What is Teletext?

Teletext is a service provided by the BBC and the IBA which makes available a wide variety of information through the medium of television. This information could be share prices on the stock market or the latest football results; the possibilities are almost endless.

Teletext information is transmitted from BBC and IBA television transmitters and can be received on a commercial television receiver suitably equipped with a Teletext decoder. The transmitted signal, however, unlike a normal television signal, is in digital form which makes it additionally suitable for use with computers.

The total amount of Teletext information is too large to be displayed on a television screen at any one instant and for this reason it is transmitted in 'pages' rather like the pages of a book. Only one page can be displayed on the screen at a time.

A page of information may contain text, symbols, or a mixture of both; it depends on the type of information and how the broadcasters decide to present it.

Because of the amount and variety of information available, transmitted Teletext pages are organised and numbered in such a manner as to enable you to locate and display specific items of information both quickly and easily.

The service broadcast by the different channels usually consists of one or more 'magazines'. These magazines can incorporate up to 255 pages. Page references consist of three digits. The first digit always refers to the magazine number and as there is a maximum of eight magazines, can be any number from 1 to 8 (for OSWORD calls, 8 is represented as 0).

The magazine number is followed by a two digit hexadecimal number. Page &00 normally contains an index to the magazine. Only those pages whose number is entirely numeric (i.e. no letters) are used for information that is meant to be displayed. The other page numbers are used for computer-readable information.

Each page may contain more than one screen of information. Each of these screens is given a sub-page number, which is a four digit hexadecimal number. The sub-pages are sent in cycles, so when the last sub-page has been sent, the broadcast returns to the beginning of the cycle and re-transmits the first sub-page. The cycle continues until a new page is selected.

B Hints on Teletext Reception

Generally, a good receiving system is as important for correctly-decoded Teletext as it is for receiving ordinary television broadcasts but, because of the digital nature of the Teletext signal, good reception is even more critical in certain situations. To display pages of text, Teletext relies on instructions received with the television signal. Depending on the quality of reception these can produce anything from a perfect or near perfect display to just a hopeless jumble of characters. Unfortunately, such jumbled characters can often arise even though the ordinary television picture appears satisfactory. The main cause of the problem is delayed signals. These can come from two sources: reflected signals picked up by the aerial from nearby hills or tall structures; reflections within the aerial and distribution system itself.

Reflections External to the Aerial

Reflections received by the aerial are normally visible on television pictures as ghosting (faint extra images). A suitable receiving aerial will usually reduce the ghosting to a level which is not disturbing on pictures and also does not affect Teletext signals. As the viewer is not normally able to try a selection of aerials it is best to use the services of an aerial contractor and to specifying that good Teletext reception is required, of course.

Reflections in the Aerial System

Reflections in the aerial system can be particularly troublesome since they can rarely be seen on normal television pictures except, perhaps, as an apparent sharpening of the picture or slight double-edging on vertical detail (not to be confused with 'ringing', a regular pattern of diminishing after-images caused by deficiencies of the receiver).

The problem rarely arises where an aerial feeds a single receiver but is commonly found with incorrectly installed multiple-outlet systems where a single aerial feed is split between several receivers or aerial sockets. Multiple outlet systems are commonplace in blocks of flats but simpler, smaller scale versions are increasingly used in households. The general rule is that in order to split the signal it is not permissible to simply join an extra cable into an existing one, since this creates an impedance mis-match and sets up the reflections in the cables.

1. Household Installations

In a household installation the simplest device to split the signal is a 'passive splitter' which, because of an inherent power loss, should be used only if the signal is strong enough in the first place. In order to prevent reflections appearing in the system, a television must be connected to each outlet at all times. If you have only one television and move it from room to room then a 75Ohm termination plug should be fitted to the spare outlets when not in use. Suitable attenuators and termination plugs are available from aerial suppliers and television retailers.

If the received signal is too low to allow passive splitting, a 'distribution amplifier' should be fitted. These have between two and eight outlets depending on the make and model. The two outlet versions are frequently called 'second set amplifiers'. Although it is good engineering practice to terminate unused amplifier outlets, Teletext reception should generally not suffer if they are left unterminated, unless there is a length of unterminated cable connected to the outlet. Amplifiers of this type are useful since they usually provide a slight increase in the signal level which will compensate for losses in long cable runs.

2. Communal Systems

In large distribution systems as in blocks of flats or hotels where there are many amplifiers and long cable runs, the problem of 'pre-imaging' may arise. In this case, the television set not only receives the signal through the cable but also receives a direct signal because the receiver and cable act as an aerial. The main symptom is noticeable ghosting on the picture caused by the delay between the cable-fed signal and the direct signal reaching the television receiver. To minimise the problem care should be taken with the lead connecting the wall outlet to the television: ensure that 'double-screened' cable is used, that it is as short as possible, and that the connections are electrically sound. If this does not cure the fault, then the system may need adjusting to provide a higher output signal or a translating device should be used to distribute the television channels on different frequencies. Once again, these items are available from aerial suppliers and television retailers.

This information was provided by BBC Engineering Information Department.
For more information on Teletext and Television reception contact :

Engineering Information Department,
BBC Broadcasting House,
LONDON,
W1A IAA
Telephone 01-927 5040

C United Kingdom Network Identities

BBC1	&5FF6	Grampian TV	&CF5C
BBC2	&457F	Scottish TV	&9F4B
BBC A	&9821	ITV London	&11D2
BBC B	&0450	ITV London 2	&41BB
BBC C	&FC9C	TVS	&0827
ITV Network	&137B	TVS 2	&BB0A
ITV Network	&4954	HTV	&5AF5
Channel 4	&3F88	HTV 2	&4F1A
S4C	&2DE3	Central TV	&F4E4
Anglia TV	&DF39	Central TV 2	&6A99
Border TV	&EDEF	Tyne Tees TV	&1534
Channel TV	&3F27	Ulster TV	&C1DC
TSW	&A40B	Yorkshire TV	&5F34
Granada TV	&B51B	Not Identified	&0000

A Table of the Network Identities for the United Kingdom

The table above gives a 16 bit number for each TV station transmitting in the UK. To find the identity of the station being received you must compare the identity contained in the TSDP with the table entries. The following extract from a BASIC program includes a function to return the identity:

```

10 DIM Buffer 20
:
100 IF FNidentity = &5FF6 THEN PRINT "BBC1"
:
1000 DEF FNidentity
1005 Buffer?0=15
1010 X%= Buffer : Y% = X% DIV 256 : A% = &7A : CALL &FFF1
1020 = (Buffer?5)*256 + Buffer?6
    
```

D CP/M, PANOS, & DOS+ Telesoftware

When using the Telesoftware Terminal, the files are saved to the current I/O processor filing system (i.e. DFS, ADFS, NFS, or ANFS) and not to the co-processor's filing system.

This does not matter if the co-processor is a 6502 or Turbo, as these use the same filing systems as the I/O processor.

Similarly, if you are using PANOS[†], you can access the files directly, because PANOS also uses the I/O processor filing system, although the filenames may appear slightly different, e.g. the file "_F77.FORPROG" appears in PANOS as "FORPROG F77".

With CP/M* and DOS+* the situation is different. These co-processor filing systems do not use the same format as the I/O processor filing systems. To get round this a convert program is supplied with each one to allow files to be copied from the I/O processor filing system into CP/M or DOS+.

Caution: Care should be taken when using Teletext from the Z80 co-processor as CP/M uses the I/O processor's memory to store the disc catalogue, and this will be corrupted if Teletext is used.

[†] PANOS is a trademark of Acorn Computer PLC.

* CP/M and DOS+ are trademarks of Digital Research.

E Copyright Position on Telesoftware

The copyright situation on Telesoftware programs broadcast by the BBC is as follows:

- (i) Domestic users of a program broadcast on CEEFAX may:
 - Make two copies only for private purposes.
 - Adapt or modify it for private purposes but not for sale.
- (ii) Educational and training institutions and agencies may:
 - Record and use the program for their own educational training purposes but not for sale.
 - Adapt, modify, and distribute a program for their own educational and training purposes but not for sale.
- (iii) No part of a program may otherwise be reproduced, stored in a retrieval system or transmitted in any form or by any means, without the prior permission of the BBC, except in accordance with the 1956 copyright act.

Different concessions apply, and are set out in detail in 'Recording BBC Educational Programmes', with respect to those BBC programmes listed in 'The Annual Programme for Schools and Colleges' and/or 'The Annual Programme for Continuing Education'.

All other BBC programmes may not be recorded without the prior consent of the BBC and the holders of the copyright and performing rights in the component parts of the programmes concerned.

F Fitting the Teletext ROM

Before installing any ROMs you should switch off your computer and unplug it from the mains.

Model B

- 1 Remove the top cover. To do this:
 - a Remove the two fixing screws from the underside, they are large cross-head screws marked 'FIX'.
 - b Remove the two fixing screws at the back of the machine.
 - c Lift the top cover upwards.
- 2 Loosen the keyboard. To do this:
 - a Undo and remove the two fixing nuts and bolts at the sides of the keyboard. (Don't forget to remove the washers.)
 - b Move the keyboard *carefully* to reveal the ROM sockets at the front right of the circuit board. (The keyboard is connected to the circuit board by a red and black twisted wire and a flat grey cable. If you wish you can unplug these from the circuit board so as to remove the keyboard completely. Before removing them notice carefully how they plug into the circuit board so that you can replace them correctly.)
- 3 Plug the ROM into one of the sockets marked by the arrows in the diagram below. The ROM should be inserted with the dimple at the top facing the rear of the machine. The BASIC and filing system chips may be in different sockets on your computer. This does not matter but normally the ROM you are inserting should go to the left of BASIC. If there is no empty socket to the left of BASIC, you may have to move the ROMs. If you wish Teletext to start when you switch on the computer, you should insert it to the right of BASIC, and any other language ROMs you have.

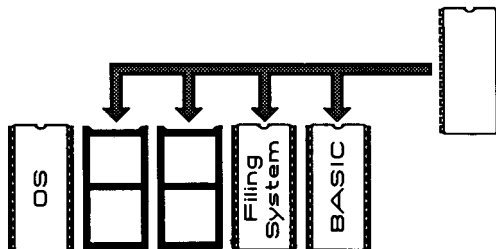

CAUTION: Handle the ROM with care and do not touch the pins. Make sure that the ROM is correctly aligned with the socket.

Each pin should fit into a hole, and there should be none hanging over the edge of the socket. Make sure that all the pins are correctly seated before pushing the ROM home.

DO NOT USE EXCESSIVE FORCE. If a pin is not correctly seated it is easy to bend it up under the ROM if you push too hard.

4 Replace the keyboard.

- a If you have unplugged the wire and cable, carefully plug them back into the the circuit board.
- b Replace the nuts and bolts securing the keyboard. Do not forget the washers, which go between the nuts and the keyboard base.

5 Replace the top cover.

- a Place the cover in position.
- b Replace the two fixing screws in the base and the two at the back and tighten.

6 Replace the mains power plug and switch on the computer.

Model B+

1 Remove the top cover. To do this:

- a Remove the two fixing screws from the underside, they are large cross-head screws marked 'FIX'.
- b Remove the two fixing screws at the back of the machine.
- c Lift the top cover upwards.

2 The ROM sockets on the Model B+ are located in the top left hand area of the circuit board (near the large copper-coloured power supply, towards the back of the computer). There are six sockets arranged in two rows of three. Nearer the keyboard are two very similar sockets for the speech system. **Under no circumstances should a ROM be placed in these speech sockets.** Some of the six ROM sockets will already contain ROM's and the top-right ROM should not be moved, as this contains the operating system. The diagram below shows the ROM sockets on the Model B+, along with the two speech sockets.

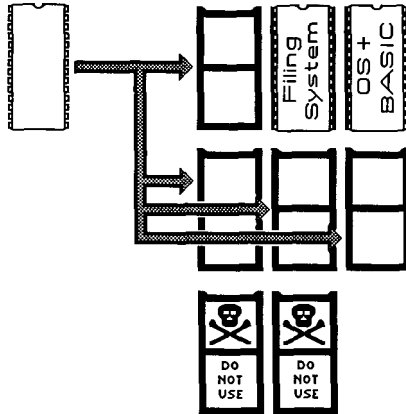

The ROM Sockets on the Model B+

CAUTION: Handle the ROM with care and do not touch the pins. Make sure that the ROM is correctly aligned with the socket.

Each pin should fit into a hole, and there should be none hanging over the edge of the socket. Make sure that all the pins are correctly seated before pushing the ROM home.

DO NOT USE EXCESSIVE FORCE. If a pin is not correctly seated it is easy to bend it up under the ROM if you push too hard.

5 Replace the top cover.

a Place the cover in position.

b Replace the two fixing screws in the base and the two at the back and tighten.

6 Replace the mains power plug and switch on the computer.

Master Series

The simplest way to use the ROM with a Master, is to use the EPROM cartridge (ADF13), available from your Acorn Dealer. Otherwise you will have to insert the ROM into one of the three internal ROM sockets.

1 Remove the top cover. To do this:

- a Remove the four fixing screws from the underside, they are large cross-head screws marked 'FIX'.
- b Lift the top cover upwards.

2 The ROM sockets on the Master are located on the far right hand side of the circuit board, just above the cartridge slots. There are four, arranged one above the other. The top socket contains the 128K Operating System ROM. Of the remaining three, the middle one is the easiest to use. Insert the ROM as before, making sure the dimple at the top of the ROM goes on the left.

If the middle socket is occupied you will have to change two links on the circuit board. If you want to use the top socket, i.e. the one below the 128K ROM, you should change link 19 so that the two right-most pins are connected. This will disable banks 6 and 7 of the sideways RAM, and replace them by the ROM. To use the bottom-most ROM socket you should change link 18 so that the two right-most pins are connected. This will disable banks 4 and 5 of the sideways ROM, and incidentally, stop the 'Convert' program from working.

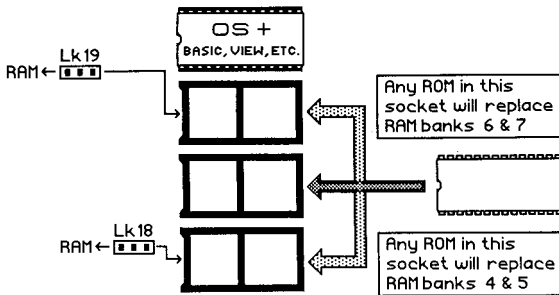

The ROM Sockets on the Master Series

3 Replace the top cover.

- a Place the cover in position.
- b Replace the four fixing screws in the base and tighten.

4 Replace the mains power plug and switch on the computer.

G Summary of OS Commands

*BBC <1/2/3/4>	Select channels 1,2,3 or 4.
*CH <1/2/3/4>	Select channels 1,2,3 or 4.
*DATA <Address>	Transfer 2K of Teletext data into memory.
*DATE	Display the local date (from TSDP).
*DISPLAY <Address>	Display Teletext data held in memory.
*HOFF	Turn off the changing top line.
*HON [1]	Turn on the changing top line.
*ITV <1/2>	Select channels 3 or 4.
*MAGAZINE <Mag>	Select magazine whose top lines will be displayed.
*NOTTX	'Unplug' the Teletext ROM.
*PAGE <Page Number>	Select the page to be captured.
*S4C	Dewiswch Sianel Pedwar Cymru. (Select Channel 4 Wales.)
*TELESOFT	TFS emulation mode
*TELETEXT	Enter the Teletext terminal.
*TIME	Display the local time (from TSDP).
*TRANSFER <Address>	Transfer 1K of Teletext data into memory.
*TTX ON/OFF	Turn the Teletext system on or off.
*TUNE	Tune the current TV channel.

H Summary of Terminal Keys

SHIFT	Tune	BBC1	BBC2	ITV	Ch4/S4C	Load Page	Save Page	
TELETEXT	Index	Red Link	Green Link	Yellow Link	Blue Link	Reveal	Hold	Sub-page

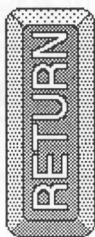
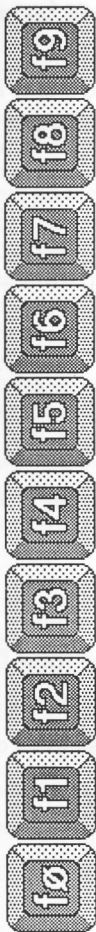

Terminal Status



Previous Page

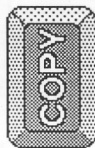

Keep/Release Page



+

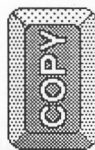

Release All Kept Pages

