

MEMORY PCB LAYOUT.

Qty.	Part No.	Description	Supplier
		IC SOCKETS	
3	IC1-3	68-PIN PGA 10x10 0.1" GRID	FARNELL 175-965
		TEXAS COS SERIES 0.3" DIL'S	
3	IC11-13	14-PIN	
4	IC4-7	20-PIN	
2	IC8-9	24-PIN	
		PROCESSOR BOARD REPLACEMENT SOCKET PRECISION TURNED PIN TYPE	
1		64-PIN EMC PART NO 21964-47-445	SCOTT ELECTRONICS.
		INTEGRATED CIRCUITS.	
1	IC1	MC68010R10 10x10 GRID PROCESSOR	/MOTOROLA
2	IC2,3	MC68451R10 10x10 GRID MEMORY MANAGEMENT	/MOTOROLA
1	IC12	74F08	
1	IC11	74F11	
1	IC13	74S03	
2	IC4,5	74F245	
2	IC6,7	74F373	
2	IC8,9	PAL'S 20L8ACNS	/MMI

EDINBURGH UNIVERSITY	ISSUE	No.	DATE	DRN.	CHK'D
	A	-	24/4/87	J.J.	
DEPT.	COMPUTER SCIENCE				

TITLE	COMPONENTS LIST
M68000 VM DAUGHTER BOARD	A4/161

Cct. Ref.	Qty.	Description	Supplier
	1	M68000 VM DAUGHTER BOARD CSD 161 REV A	
		RESISTOR NETWORKS	
RN1,2	2	8-PIN SIL'S 7x1K RESISTORS PIN 1 COMMON AB MICRO 770 SERIES OR R.S. COMPONENTS	STC 95430F RS 149-262
		CAPACITORS	
CI-16	16	AXIAL SOLID ELECTROLYTE TANT. (POLARISED) 1uF 35VW	RS 104-815
		TERMINAL STRIPS	
	2	32-PIN 14132-58-445	SCOTT ELECTRONICS
		DELAY LINE	
IC10	1	10 TAP 5nS/TAP 50nS OVERALL	FARNELL 175-218

EDINBURGH UNIVERSITY		ISSUE	No.	DATE	DRN.	CHK'D
		A	-	24/4/87	J.J.	
DEPT. COMPUTER SCIENCE						
TITLE M68000 VM DAUGHTER BOARD.			COMPONENTS LIST A4/161 SHEET 1 OF 2			

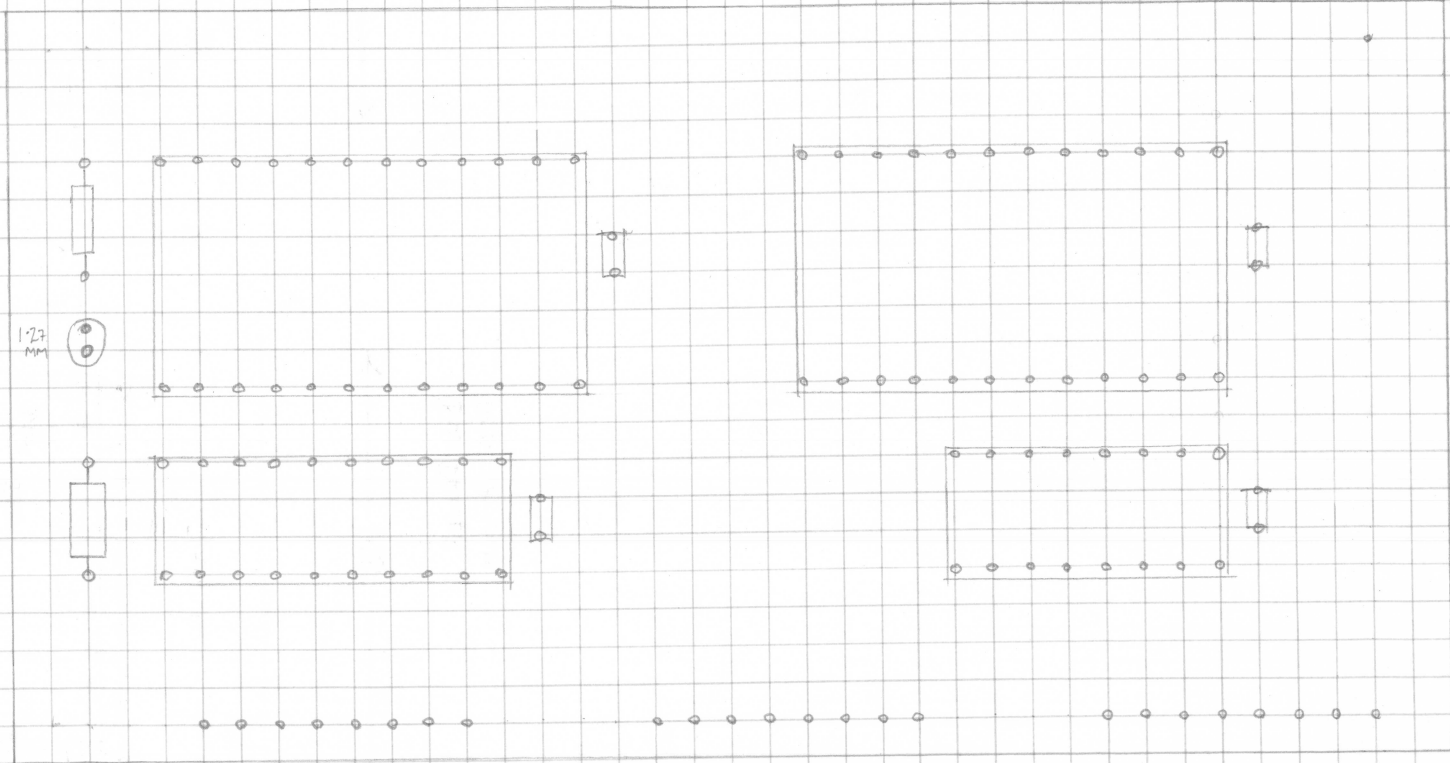

ALU PCB LAYOUT.

CUSTOMER: Edin Univ PART NO: C/S / D142 NES NO: 4183 INCH / ~~METRIC~~

AUTO / ~~MANUAL~~ NO. OF CTS: 1 ELECT TEST: Y DWG NO: 1 ~~SINGLE~~ / DOUBLE

TMP: 1 WORKS ZERO XL3: Y COMMENTS: STACK HEIGHT DRILL
 CONY: 1 WORKS ZERO EX200: Y
 M/L: 1 WORKS ZERO EX300: Y

Slope Tool

LS
 Drillng

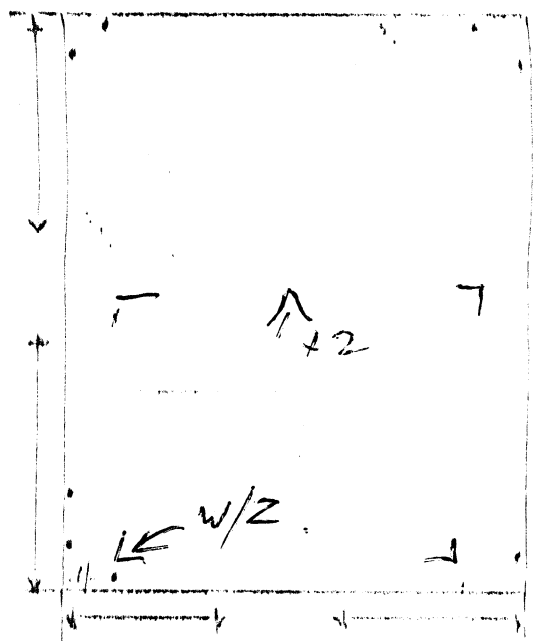

Tool Matrix

Material

1	Y
2	Y
3	Y
4	Y
5	Y
6	Y
7	Y
8	Y
9	Y
10	Y
11	Y
12	Y
13	Y
14	Y
15	Y
16	Y
17	Y
18	Y
19	Y
20	Y
21	Y
22	Y
23	Y
24	Y
25	Y
26	Y
27	Y
28	Y
29	Y
30	Y
31	Y
32	Y

1	Y
2	Y
3	Y
4	Y
5	Y
6	Y
7	Y
8	Y
9	Y
10	Y
11	Y
12	Y
13	Y
14	Y
15	Y
16	Y
17	Y
18	Y
19	Y
20	Y
21	Y
22	Y
23	Y
24	Y
25	Y
26	Y
27	Y
28	Y
29	Y
30	Y
31	Y
32	Y

Dimension Matrix

Order #	Date	Loc	Mat	Part	Mat. Rev
101	3/20	EXT	Loc		
102	3/32	COMP	011		
103					
104					
105					
106					
107					
108					
109					
110					
111					
112					
113					
114					
115					
116					
117					
118					
119					
120					
121					
122					
123					
124					
125					
126					
127					
128					
129					
130					

M48

To2 F050S22

¹⁰
m25

To201

600x y -

m15 F05

042.

601x05661 y

x05661 y045

m16

040

600x05661 y0461

m15 F05

042

601x05661 y09189

x0411 y09189

m16

040

600x04 y09189

m15 F05

042

601x y09189

x y0411

m16

040

600x y04

m15 F05

042

601x y-001

m16

040

m24

m26 x y09689

m26

m27

m30

CUSTOMER	PART NO	ISSUE	NO C/T	SOR D/S	NEG. NO	Run Time
EDINBURGH/UNIV	C/S/D142	1	2	DS	4153	

ALLEN TO Rows of lcc's up left of Cct. Move to "C" PADS and move down to bottom left; hand cover Block & w/2

X-001
Y-08939

WORKS ZERO	XL3	X	Y
WORKS ZERO	EX200	X	Y

w/2
1.7 in
9 up.

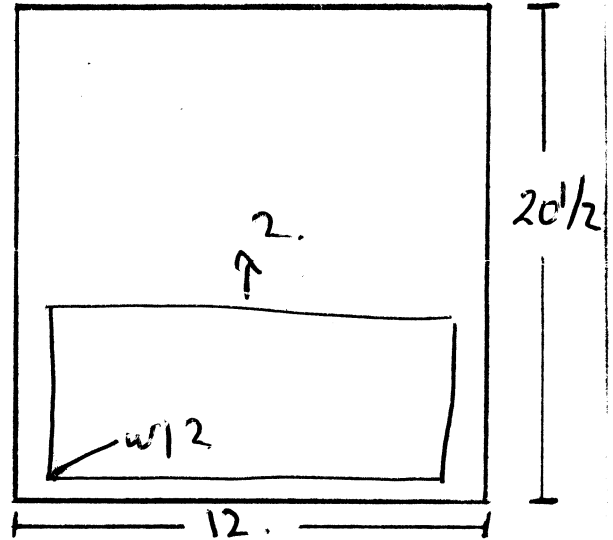

No	Drill Size	Ref.	No Holes	X	TOTAL
#1	3.175	Ext Luc	3		3
#1	3.175	Print	8		8
#2	.85	E	925	x2	1850
#3	1.05	A	1823	x2	3646
#4	1.25	G.	72	x2	144 +1
#5	1.70	C	1	x2	2
#6	2.80	B	4	x2	8
#7	3.20	D	2	x2	4
9	.				
10	.				
11	.	W/2			
12	.	Pass			
13	.	9/16/83			
14	.				
15	.				
16	.				
17	.				
18	.				
19	.				
20	.				
21	.				
22	.				
23	.				
24	.				

F.S.	AUTO	MANUAL
F.S.	Inch	METRIC

Step
m01
m0209689
m02

Total
X003 Y-003
X-003 Y003
X-003 Y18
X003 Y192
X08 Y142
X09 Y18
X09 Y003
X08 Y-003

EXT LUC
X05 Y-005
X05 Y195
X10 Y06

"C" PAD
X001 Y08939

Cct. Ref.	Qty.	Description	Supplier
	1	DMACK BOARD CSD 159	
		RESISTORS (DISCRETES)	
		(U.O.S. ARE MR25 METAL FILM $\pm 2\%$ 0.4W)	
	4	470R: R1-R4	
	4	1K: R5-R8	
	3	470R: R11-R13	
	3	1K: R14, R15, R17	
	1	220R: R16	
	2	150R: R9, R10	
		RESISTOR NETWORKS	
RP1	1	150R 8 ISOLATED RESISTORS 16-PIN DIL 25386H	STC / 316 B SERIES ALLEN BRADLEY
RP2,3	2	1K 8 RESISTORS 9-PIN SIL 90501X	STC / 850 SERIES ALLEN BRADLEY
		CAPACITORS	
C1, C2	2	15p POLYSTYRENE 113-213	R.S.
C3, C4	2	22 μ F/16V TANT 100-882	FARNELL / DUBILIER
	41	1 μ F/35V TANT (DECOUPLERS) 100-900	FARNELL / DUBILIER
D2, D3	2	DIODES 1N4002	
SW1, 2, 3	3	HEX SWITCHES (DIL ROTARY PCB) 143-615	FARNELL
X1	1	QUARTZ XTAL FREQ 3.6864MHZ 103-912	FARNELL
OSC1 (A5)	1	XTAL CONTROLLED OSC WITH TTL OUTPUT (32MHZ OVERSIZED 14-PIN DIL PACKAGE)	ECM SERIES GBS 205
F51	1	FUSE TDC26-250mA 08202H	FARNELL
		SCREWS/NUTS/WASHERS (M2.5)	
	14	BRASS (NICKEL PLATED) SLOTTED PAN HEAD X.12MM	101-435 FARNELL
	14	STEEL NUTS CADMIUM PLATED 101-443	FARNELL
	14	NYLON/PLASTIC WASHERS	PLASTIC SCREWS LTD.

EDINBURGH UNIVERSITY DEPT. COMPUTER SCIENCE	ISSUE	No.	DATE	DRN.	CHK'D
	A	-	18-3-85	J.J.	
	B	126	29-4-85	J.J.	
	C	129	30-9-85	J.J.	

TITLE	COMPONENTS LIST
DMACK BOARD	A4/159
	SHEET 1 OF 3

Cct. Ref.	Qty.	Description	Supplier
		CONNECTORS	
A	1	EUROCONNECTOR 96-WAY PLUG WITH 90° SOLDER TAILS 100-975	FARNELL/MCMURDO
C	1	EUROCONNECTOR 64-WAY (3 ROW WITH 90° SOLDER TAILS) 100-974	FARNELL/MCMURDO
		MALE PCB HEADERS (RIGHT ANGLE SOLDER TAIL WITH LATCHES)	
CB	1	10-WAY (BUMP POLARIZED) 145-034	FARNELL
CA	1	26-WAY 145-029	"
M	1	20-WAY 145-028	"
DO, DI	2	34-WAY 145-030	"
		BERG DUBOX SYSTEM CONNECTOR	
BA	1	2x4 WAY RIGHT ANGLE D WALLED HEADER 76383-404	CARGILL/BERG
		COMPONENT CARRIER 16-PIN (ARBITOR RESISTORS) 702-3728-01-04-00	ICAMBION
		IC SOCKETS TEXAS C88 SERIES	
	17	14-PIN	
	2φ	16-PIN	
	6	20-PIN	
	2	28-PIN	
	1	40-PIN	

EDINBURGH UNIVERSITY	ISSUE	No.	DATE	DRN.	CHK'D
	A	—	18-3-85	J.J.	
DEPT. COMPUTER SCIENCE	B	129	30-9-85	J.J.	
TITLE DMACK BOARD			COMPONENTS LIST A4/159 SHEET 2 OF 3		

Cct. Ref.	Qty.	Description	Supplier
		INTEGRATED CIRCUITS	
	2	7405	G6, H7
	1	74S05	D7
	1	74S38	E7
	1	74S163	B5
	2	75108 or MC1488	G4, H4
	1	75189A or MC1489A	G3
	2	WD1772 FLOPPY DISK CONTROLLER	F5, F7
	1	SCN2681AC-1N40 DUART	F3
	1	AM26LS32P or MC3486P	H3
			/WESTERN DIGITAL
			MULLARD/SIGNETICS
			/AMD
	1	LS08	E5
	1	LS10	E3
	2	LS14	B7, L3
	2	LS32	C3, E2
	1	LS86A	F2
	1	LS138	K2
	2	LS163A	C6, E6
	1	LS174	G2
	6	LS191	A2, A3, A4, B3, C4, D4
	1	LS240	D3
	3	LS257B	B2, B4, D5
	1	F00	C7
	1	F64	B6
	1	F94	C5
	3	F245	C2, D2, H2
	1	F374	A6
	1	F521	C1

EDINBURGH UNIVERSITY	ISSUE	No.	DATE	DRN.	CHK'D
	A	-	18-3-85	J.J.	
	B	126	29-4-85	J.J.	
	C	129	30-9-85	J.J.	
DEPT.	COMPUTER SCIENCE				
TITLE	DMACK BOARD		COMPONENTS LIST		
			A4/159		
			SHEET 3 OF 3		

Quantity	Description	Supplier
1	PCB TYPE CSD156 REV B	
	I.C. SOCKETS (TIN SOLDER TAIL)	
1	8-PIN CBB-08-01	QUARNDON / TEXAS
32	14-PIN CBB-14-01	" "
81	16-PIN CBB-16-01	" "
8	20-PIN CBB-20-01	" "
SW1	1 TOGGLE SWITCH (SINGLE POLE 3 POS ^N) F47 3031	WEST HYDE DEVELOPMENTS LTD.
SW3-5	3 HEX SWITCHES (DIL ROTARY PCB) 143-615	FARNELL
	1 CARD EJECTORS (5-PAIR PACK) 41-1274L	VERO
	CONNECTOR	
A	1 EUROCONNECTOR 96-WAY PLUG WITH 90° SOLDER TAILS ORDER CODE 100-975	FARNELL
	CONNECTOR FIXINGS (SCREWS/NUTS)	
	2 M2.5 FLAT HEAD x 10MM LONG 101-433	FARNELL
	2 M2.5 NUTS 101-443	"

EDINBURGH UNIVERSITY	ISSUE	No.	DATE	DRN.	CHK'D
	A	—	18-4-85		
DEPT.	COMPUTER SCIENCE				
TITLE	MEMORY BOARD (2MBYTE)		COMPONENTS LIST		
			A4/156		
			SHEET 1 OF 3		

Cct. Ref.	Qty.	Description	Supplier
		INTEGRATED CIRCUITS	
	3	AM2965: E1, E17, F3	
	1	MC140466 : F19 (SPECIAL VOLTAGE REG.)	HAWKE / MOTOROLA
	4	MC10124: F14, F16, F17, F20	
	3	MC10318L: G14, G17, G20	CERDIS / MOTOROLA
	4	MCM93422: E2, E3, E5, E7 256 X 4 BIPOLAR STATIC RAM.	
	8	54LS166: A1, A20, B1, B20, C1, C20, D1, D20.	
	9	F00 : A7, B7, C7, D7, E10, E11, E19, F10, F11	
	1	F02 : F6	
	1	F20 : G6	
	2	F74 : E14, G8	
	1	F157 : F4	
	4	F175 : G1, G3, G4, G7	
	5	F374 : E8, E13, F8, F13, G2	
	2	F399 : F1, F2,	
		MEMORY 64K X 1 DEAMS 150ns	
		μPD4164C-3; MB8264-15	
	64	A2-A5; A8-A19;	
		B2-B5; B8-B19;	
		C2-C5; C8-C19;	
		D2-D5; D8-D19;	

EDINBURGH UNIVERSITY	ISSUE	No.	DATE	DRN.	CHK'D
	A	-	12-3-84	J.J.	
DEPT. COMPUTER SCIENCE	B	128	20-9-85	J.J.	
TITLE GRAPHICS SLAVE BOARD			COMPONENTS LIST A4/155 SHEET 3 OF 3		

Cct. Ref.	Qty.	Description	Supplier
		RESISTORS	
		U.O.S. ARE MR25 METAL FILM $\pm 1\%$ 0.4W	FARNELL / MULLARD
75R	6	R5, R6, R11, R12, R16, R17	
390R	3	R7, R10, R15	
3K3	3	R8, R13, R18	
3K9	3	R9, R14, R19	
1K	4	R1, R2, R3, R4	
		POTENTIOMETERS	
1K	3	VR1, VR2, VR3	D75-207 1K FARNELL / DUBILIER
470R	3	9-PIN SIL'S (ALLEN BRADLEY 900 SERIES 909A) RP1, RP2, RP3	2544 3X STC / ALLEN BRADLEY
		CAPACITORS	
.01 μ F	3	C1, C2, C3 WIMA FKS2 SERIES (POLYESTER)	143-691 FARNELL / WIMA
1 μ F	118	35VW TANTALUM DUBILIER	100-900 FARNELL / DUBILIER
47 μ F	1	6.3VW TANT	100-863 FARNELL / DUBILIER
47 μ F	2	16VW TANT	100-884 " / "
REG1	1	MCT905.2CT VOLTAGE REGULATOR (TO-220)	DERMYN / MOTOROLA
	1	HEAT SINK (FOR VOLTAGE REG.) LARGE	170-071 FARNELL /
	1	HEAT SINK (" " ") SMALL	170-073 FARNELL
	PACK	VOLTAGE REG. INSULATING KIT	170-649 FARNELL /
		(PACK OF 10)	
	PACK	VOLTAGE REG. FIXING KIT	170-020 FARNELL /
		(PACK OF 10)	

EDINBURGH UNIVERSITY	ISSUE	No.	DATE	DRN.	CHK'D
	A	-	12-3-84	J.J.	
	B	128	20-9-85	J.J.	
DEPT.	COMPUTER SCIENCE				
TITLE	GRAPHICS SLAVE BOARD				COMPONENTS LIST A4/155 SHEET 2 OF 3

Cct. Ref.	Qty.	Description	Supplier
	1	PCB TYPE CSD 155 REV B	
		CONNECTORS	
	1	EUROCONNECTOR 96-WAY PLUG WITH 90° SOLDER TAILS 100-975	FARNELL/MCMURDO.
	42	AMP MODU MOD 1 RECEPTICLES SOCKETS 141007-2	AMPLIVERSAL/AMP
			/AMP
		CONNECTOR FIXINGS	
		EUROCONNECTOR	
		STEEL SCREWS/NUTS	
	2	M2.5 FLAT HD X 10mm LONG	
	2	M2.5 NUTS	
		CO-AXIAL CONNECTORS	
	6	SDR SMB ELBOW JACK SNAP-ON (PCB MOUNTING) GE65210	GREENPAR/FARNELL
		IC SOCKETS TEXAS C88 SERIES	
	1	8-PIN	
	13	14-PIN	
	86	16-PIN	
	8	20-PIN	
	4	22-PIN	

EDINBURGH UNIVERSITY	ISSUE	No.	DATE	DRN.	CHK'D
	A	—	12-3-84	J.J.	
DEPT.	B	130	1-10-85	J.J.	
COMPUTER SCIENCE					
TITLE	COMPONENTS LIST				
GRAPHICS SLAVE BOARD	A4/155				
	SHEET 1 OF 3				

Cct. Ref.	Qty.	Description	Supplier
	1	PCB TYPE CSD 153	
		IC SOCKETS	
	44	14-PIN	
	20	16-PIN	
	9	20-PIN	
	4	24-PIN 0.6"	
	4	28-PIN 0.6"	
SW2 -SW5		HGX SWITCHES 143-615	FARNELL
LD1-LD6	3	LEDS (DUAL) WEST HYDE F011131	
		CONNECTORS	
A	1	EUROCONNECTOR 96-WAY PLUG WITH 90° SOLDER TAILS 100-975	FARNELL/McMURDO
C	1	EUROCONNECTOR 64-WAY PLUG 3 ROW WITH 90° SOLDER TAILS 100-974	FARNELL/McMURDO
		MOLEX 0.1" PITCH KK CONNECTORS 4094-A 90° PINS	
BA	1	6-WAY 143-147	FARNELL
BB	1	3-WAY 143-145	"
		CONNECTOR FIXINGS	
		EUROCONNECTORS	
		STEEL SCREWS/NUTS	
	4	M2.5 FLAT HEAD X 10mm LONG 101-433	FARNELL
	4	M2.5 NUTS 101-443	"

EDINBURGH UNIVERSITY	ISSUE	No.	DATE	DRN.	CHK'D
	A	-	13-9-84	J.J.	
DEPT.	COMPUTER SCIENCE				
TITLE	BUS CONTROLLER		COMPONENTS LIST		
			A4/153		
			SHEET 1 OF 4		

Cct. Ref.	Qty.	Description	Supplier
		RESISTORS	
		(U.O.S ARE MR25 METAL FILM $\pm 2\%$ 0.4W)	
	2	27R: COMPONENT CARRIER @ E1	
	1	470R: R10	
	7	1K: R1, R4 - R9	
	1	22K: R2	
	1	120K: R3	
		RESISTORS SIL'S	
		ALLEN BRADLEY 900 SERIES.	
	6	8x1K 9-PIN: RP1 - RP6 25445G (NB RP3, RP4 CUT TO 7-PIN SIZE)	STC
		CAPACITORS	
C1	1	0.1 μ F/100V POLYESTER 344-25104	FARNELL/MULLARD
C2	1	0.22 μ F/100V " 344-25224	" "
C3,C4	2	47 μ F/16V TANTALUM SH SERIES 100-884	FARNELL/DUBILIER
E1	2	47pF/100V CERAMIC PLATE 632-34479 (COMPONENT CARRIER @ E1)	FARNELL/MULLARD
	50	1 μ F/35V TANTALUM SH SERIES 100-900 (DECOUPLERS)	FARNELL/DUBILIER
		XTAL OSC. MODULE (OVERSIZED DIL PACKAGE)	
		4.9152 MHz DIL1100C SERIES 50857F	STC
		COMPONENT SOCKET ADAPTORS	CAMBION
E1	1	COMPONENT CARRIER 8-PIN (CAMBION 702-3720-01-04-00)	/CAMBION

EDINBURGH UNIVERSITY	ISSUE	No.	DATE	DRN.	CHK'D
	A	-	13-9-84	J.J.	
DEPT.					
COMPUTER SCIENCE					
TITLE	COMPONENTS LIST				
BUS CONTROLLER	A4/153				
	SHEET 2 OF 4				

Cct. Ref.	Qty.	Description	Supplier
D13, E13 F13, G13	UP TO 4	COMPONENT CARRIER 16-PIN (CAMBION 702-3728-01-04-00) ASSEMBLED AS PER REQUIREMENTS.	/CAMBION
		RIBBON CABLING & CONNECTORS ASSEMBLED AS PER REQUIREMENTS	
	UP TO 4	24-WAY DIP LOW PROFILE PLUG 609-M245H	FARNELL/ANSLEY
	UP TO 4	25-WAY 'D' TYPE SOCKET 609-255	FARNELL/ANSLEY
		25-WAY 'BLUE MAC' RIBBON CABLE 100 FT REEL 171-25-100	FARNELL/ANSLEY
		CABLE LENGTHS CUT AS REQUIRED	
	1	CABLE CLAMP 145-426	FARNELL

EDINBURGH UNIVERSITY	ISSUE	No.	DATE	DRN.	CHK'D
	A	-	13-9-84	J.J.	
DEPT.					
COMPUTER SCIENCE					
TITLE	COMPONENTS LIST				
BUS CONTROLLER BOARD.	A4/153				
	SHEET 3 OF 4				

Cct. Ref.	Qty.	Description	Supplier
		INTEGRATED CIRCUITS	
	10	F00	
	4	F04	
	+	F10	
	2	F20	
	5	F64	
	4	F74	
	1	F139	
	2	F148	
	2	F153	
	1	F161	
	1	F174	
	3	F175	
	3	F240	
	1	F244	
	1	F245	
	2	F257	
	1	F373	
	2	F521	
	1	LS123	
	1	LS123	
	2	LS256	
	1	LS393	
	2	'S05	
	1	'S10	
	1	'S38	
	1	'S24	
	2	'S260	
	4	MC1488P	
	4	MC1484AP	
	4	SEN 2661BC 1N28 (28 PIN 0.6" PITCH)	JERMYN / SIGNETICS

EDINBURGH UNIVERSITY	ISSUE	No.	DATE	DRN.	CHK'D
	A	—	13-9-84	J.J.	
DEPT.					
COMPUTER SCIENCE					
TITLE	COMPONENTS LIST				
BUS CONTROLLER BOARD	A4/153				
	SHEET 4 OF 4				

Cct. Ref.	Qty.	Description	Supplier
	1	PCB TYPE CSD 142 REV B	
		XTAL OSCILLATOR MODULE	
	1	16.0MHZ 170-238	FARNELL
		CONNECTORS	
		EUROCONNECTOR 96-WAY PLUG	
A	1	WITH 90° SOLDER TAILS 100-975	FARNELL/MCMURDO
		EUROCONNECTOR 64-WAY PLUG	
C	1	(3 ROW WITH 90° SOLDER TAILS) 100-974	FARNELL/MCMURDO
D	1	D-TYPE 15-WAY SOCKET 146-273	FARNELL/CANNON
		CONNECTOR FIXINGS	
		EUROCONNECTORS	
		STEEL SCREWS/NUTS	
	4	M2.5 FLAT HEAD X 10mm LONG	
	4	M2.5 NUTS	
		D-TYPE CONNECTOR	
	2	M3 SCREWS FLAT HEAD X 10mm LONG	
	2	M3 NUTS	
	2	M3 SHAKEPROOF WASHERS	

EDINBURGH UNIVERSITY	ISSUE	No.	DATE	DRN.	CHK'D
	A	—	15-6-83	J.J.	
DEPT.	COMPUTER SCIENCE				
TITLE	ETHERNET BOARD		COMPONENTS LIST		
			A4/142		
			SHEET 1 OF 4		

Cct. Ref.	Qty.	Description	Supplier
		IC SOCKETS	
	50	14-PIN C88-14-φ1	QUARNDON/TEXAS
	23	16-PIN C88-16-φ1	
	11	20-PIN C88-20-φ1	
A3-A5 A7-A9	6	24-PIN C88-24-φ1	
	2	40-PIN C88-40-φ1	
A1	1	24-PIN 170-108	FARNELL/CAMBION
		INTEGRATED CIRCUITS	
		74LS SERIES	
LSφφ	5		
LSφ2	2		
LSφ4	3		
LSφ8	6		
LS1φ	2		
LS11	2		
LS27	1		
LS3φ	2		
LS32	2		
LS52	1		
LS74	13		
LS126A	1		
LS138	3		
LS148	1		
LS157	1		
LS161A	5		
LS164	4		
LS165	1		
LS174	2		
LS175	1		
LS191	2		
LS244	5		
LS273	1		
LS373	2		
LS374	2		

EDINBURGH UNIVERSITY	ISSUE	No.	DATE	DRN.	CHK'D
	A	—	15-6-83	J.J.	
DEPT. COMPUTER SCIENCE	B	119	15-7-83	J.J.	
TITLE <u>ETHERNET BOARD</u>			COMPONENTS LIST A4/142 SHEET 3 OF 4		

Cct. Ref.	Qty.	Description	Supplier
505	1	745 SERIES	
586	1		
5260	2		
AM25 LS2521	1	8-BIT COMPARATOR	QUARNDON/AMD
8T13	1		/SIGNETICS
8T14	1		/SIGNETICS
8X01	1	CRC GENERATOR/CHECKER	ITT / SIGNETICS
AM2810	5	64 X 4 FIFO	/AMD
Z80A	1	MICROPROCESSOR	/ZILLOG/MOSTEK
8257-5	1	PROGRAMMABLE DMA CONTROLLER	/INTEL/AMD
		EPROM 4Kx8 ACCESS TIME 450NS	
1		2732 / TMS2532 / MPD2732 / HN462732	
		EPROM 2Kx8 ACCESS TIME 450NS	
		2716 / TMS 2516 / MPD2716 / HN462716	
		STATIC RAM 2Kx8 ACCESS TIME 200NS	
6		HM6116P-4 / MPD446	

EDINBURGH UNIVERSITY	ISSUE	No.	DATE	DRN.	CHK'D
	A	—	15-6-83	J.J.	
DEPT.	COMPUTER SCIENCE				
TITLE	ETHERNET BOARD		COMPONENTS LIST		
			A4/142		
			SHEET 4 OF 4		

Cct. Ref.	Qty.	Description	Supplier
	1	PCB REF CSD 138 REV B	ASHDOWN
	1	GUIDE BLOCK (DRWG. A4/145)	
		GUIDE BLOCK SCREWS	
	2	M4 x 10mm	
		AMP MOD 11 RECEPTICLES (.025" x .025")	
	3	PART N° 85866-4	AMP
		15-WAY D-TYPE CONNECTOR 90° PINS	
PL1	1	PLUG 467-841	/R.S.
		SLIDING LOCK POSTS D53018	
	1	STOCK N° 44070X (FOR 2 SETS)	CANNON/ITT
REG1	1	REGULATOR 12/5V μ A7805MC (TO-220)	FAIRCHILD
		REGULATOR MOUNTING KIT	
		TO220AB 402-456	/R.S.
		(CONTAINS 10 MICA WASHERS + 10 INSUL. BUSHES)	
	1	M3 C'SK HD x 7mm	
	1	M3 NUT	
PS1	1	DC TO DC CONVERTER 600mA 3WSRS	RELIABILITY/THAME
RL1	1	DIL REED RELAY 349-383	/R.S.
		INTEGRATED CIRCUITS	
IC6	1	LS04 HEX INVERTER	
IC8	1	LS74 DUAL D-TYPE F/F	
IC10	1	LS122 RETRIGGERABLE MONO	
IC4	1	8T13 DUAL LINE DRIVER	SIGNETICS /
IC2	1	8T14 TRIPLE LINE RECEIVER	" /
IC7, IC9	2	75140 DUAL LINE RECEIVER	TEXAS /
IC5	1	75464 DUAL PERIPHERAL + NOR DRIVERS	" /
IC1, IC3	2	HCPL 2630 DUAL OPTICALLY COUPLED GATE	HEW. PACK /

EDINBURGH UNIVERSITY	ISSUE	No.	DATE	DRN.	CHK'D
	A	-	18-7-83	J.J.	
DEPT.	COMPUTER SCIENCE				
TITLE	ETHERNET TAP BOARD (CSD 138 REV B)		COMPONENTS LIST A4/138 SHEET 1 OF 2		

Cct. Ref.	Qty.	Description	Supplier
		RESISTORS	
		(ALL METAL FILM MR25 U.O.S.)	
	1	2R7 (R12) 2.5W WIREWOUND 151-603	/R.S.
	3	75R (R2, R8, R9)	/FARNELL
	4	100R (R3, R4, R5, R14)	
	2	220R (R10, R13)	
	4	330R (R1, R6, R7, R23)	
	2	1K Ω (R17, R22)	
	1	1K5 (R15)	
	1	2K Ω (R18)	
	1	2K4 (R19)	
	1	3K Ω (R16)	
	1	5K1 (R20)	
	1	10K (R21)	
	1	33K (R11)	
		CAPACITORS	
C3, C4, C6	3	22pF POLYSTYRENE 113-229	/R.S.
C8	1	1000pF " 113-320	/R.S.
C5	1	0.1 μ F 352 SERIES POLYESTER 352-44104	MULLARD / FARNELL
DECOUP.	5	1.0 μ F 35V TANTALUM 100-900	DUBILIER / FARNELL
C7	1	47 μ F 6.3V " 100-863	" "
C2, C9	2	68 μ F 6.3V ELECTROLYTIC 030 SERIES 030-33689	MULLARD / FARNELL
C1	1	68 μ F 16V " " " 030-35689	" "
		DIODES	
	5	1N4148 (D1 D3 D4 D5 D6)	MULLARD / FARNELL
	1	BYV95A (D2)	/ "
		LEDS	
LED1	1	STANDARD 0.2" (GREEN) 506-481	/R.S.
LED2	1	" " (YELLOW) 506-497	/R.S.

EDINBURGH UNIVERSITY	ISSUE	No.	DATE	DRN.	CHK'D
	A	-	18-7-83	J.J.	
DEPT.	COMPUTER SCIENCE				
TITLE	ETHERNET TAP BOARD (CSD 138 REV B)		COMPONENTS LIST A4/138		
SHEET 2 OF 2					

Cct. Ref.	Qty.	Description	Supplier
	1	PCB TYPE CSD 136 REV B	
		IC SOCKETS (TIN SOLDER TAIL)	
	1	8-PIN C88-08-01	QUARNDON/TEXAS
	30	14-PIN C88-14-01	" "
	85	16-PIN C88-16-01	" "
	8	20-PIN C88-20-01	" "
SW1	1	TOGGLE SWITCH (SINGLE POLE 3 POSITION) E47 3021	WEST HYDE DEVELOPMENT LTD.
		HEX SWITCHES (DIL ROTARY PCB) 143-615	FARNELL
SW2-SW5	4		
		CARD DETECTORS	
	1	ORDER CODE 41-1274L (PK OF 5 PAIRS)	VERO
		CONNECTOR	
A		EUROCONNECTOR 96-WAY PLUG WITH 90° SOLDER TAILS ORDER CODE 100-975	FARNELL
		CONNECTOR FIXINGS	
		SCREWS/NUTS	
	2	M2.5 FLAT HEAD x 10mm LONG 101-433	FARNELL
	2	M2.5 NUTS 101-443	"

?

EDINBURGH UNIVERSITY	ISSUE	No.	DATE	DRN.	CHK'D
	A	-			
DEPT.	B		2-6-83		
COMPUTER SCIENCE					
TITLE	COMPONENTS LIST				
MEMORY BOARD	A4/136				
	SHEET 1 OF 3				

Cct. Ref.	Qty.	Description	Supplier
	1	PCB TYPE CSD 136 REV B	
		IC SOCKETS (TIN SOLDER TAIL)	
	1	8-PIN C88-08-01	QUARNDON/TEXAS
	30	14-PIN C88-14-01	" "
	85	16-PIN C88-16-01	" "
	8	20-PIN C88-20-01	" "
SW1	1	TOGGLE SWITCH (SINGLE POLE 3 POSITION) E47 3031	WEST HYDE DEVELOPMENTS LTD.
		HEX SWITCHES (DIL ROTARY PCB) 143-615	FARNELL
SW2-SW5	4		
		CARD DETECTORS	
	1	ORDER CODE 41-1274L (PK OF 5 PAIRS)	VERO
		CONNECTOR	
A		EUROCONNECTOR 96-WAY PLUG WITH 90° SOLDER TAILS ORDER CODE 100-975	FARNELL
		CONNECTOR FIXINGS	
		SCREWS/NUTS	
	2	M2.5 FLAT HEAD X 10mm LONG 101-433	FARNELL
	2	M2.5 NUTS 101-443	"

EDINBURGH UNIVERSITY

DEPT.

COMPUTER SCIENCE

ISSUE	No.	DATE	DRN.	CHK'D
A	-			
B		2-6-83		

TITLE

MEMORY BOARD

COMPONENTS LIST

A4/136

SHEET 1 OF 3

Cct. Ref.	Qty.	Description	Supplier
		RESISTORS (DISCRETES)	
		(U.O.S. ARE MR25 METAL FILM ±1% 0.4W)	FARNELL
27R	2	COMPONENT CARRIER ASSEMBLY	
330R	1	R7	
470R	1	R6	
1K	8	R1-R5, R8-R10	
		RESISTORS (SIL'S)	
22R	5	RP7-11 8-PIN (ALLEN BRADLEY 900 SERIES)	STC 25489E
33R	4	RP3-6 8-PIN (" " " ")	STC 25490H
1K	2	RP1-RP2 9-PIN (A.B. MICROELECTRONICS 850 SERIES)	STC 90501X
		CAPACITORS	
		PLATE CERAMIC 63V	
47pF	2	COMPONENT CARRIER ASSEMBLY 125-597	R.S. COMPONENTS
		TANTALUM BEAD	
1μF	119	35V (DECOUPLERS) 100-900	FARNELL
		LEDS	
LED1,2	2	F081031 (SINGLE LED)	WEST HYDE DEV.
		COMPONENT CARRIER	
	1	8-PIN 702-3720-01-04-00	CAMBION

EDINBURGH UNIVERSITY	ISSUE	No.	DATE	DRN.	CHK'D
	A	—			
DEPT. COMPUTER SCIENCE	B		2-6-83		
TITLE MEMORY BOARD			COMPONENTS LIST A4/136 SHEET 2 OF 3		

Cct. Ref.	Qty.	Description	Supplier
		RESISTORS (DISCRETES)	
		(U.O.S. ARE MR25 METAL FILM ±1% 0.4W)	FARNELL
27R	2	COMPONENT CARRIER ASSEMBLY	
33φR	1	R7	
47φR	1	R6	
1K	8	R1-R5, R8-R10	
		RESISTORS (SIL'S)	
22R	5	RP7-11 8-PIN (ALLEN BRADLEY 900 SERIES)	STC 25489E
33R	4	RP3-6 8-PIN (" " " ")	STC 25490H
1K	2	RP1-RP2 9-PIN (A.B. MICROELECTRONICS 850 SERIES)	STC 90501X
		CAPACITORS	
		PLATE CERAMIC 63V	
47pF	2	COMPONENT CARRIER ASSEMBLY	125-597 R.S. COMPONENTS
		TANTALUM BEAD	
1μF	119	35V (DECOUPLERS)	100-900 FARNELL
		LEDS	
LED1,2	2	Fφ8 1032 (SINGLE LED)	WEST HYDE DEV.
		COMPONENT CARRIER	
	1	8-PIN 7φ2-372φ-φ1-φ4-φφ	GAMBION

EDINBURGH UNIVERSITY	ISSUE	No.	DATE	DRN.	CHK'D
	A	-			
DEPT. COMPUTER SCIENCE	B		2-6-83		
TITLE MEMORY BOARD			COMPONENTS LIST A4/136 SHEET 2 OF 3		

Cct. Ref.	Qty.	Description	Supplier
		INTEGRATED CIRCUITS	
		74F SERIES	
F00	6		
F02	1		
F04	1		
F64	9		
F74	3		
F158	8		
F175	5		
F240	1		
F245	4		
F280	4		
F374	1		
FS21	2		
		74LS SERIES	
LS393	3		
		74S SERIES	
S38	1		
S260	2		
		MEMORY IC's	
		64K X 1 DRAMS 150ns	
72		μPD4164C-3 (PLASTIC) μPD4164D-3 (CERAMIC)	/NEC
		MB8264-15 (ALTERNATIVE)	/FUJITSU
		(AT LOCATIONS B5-V5; B6-V6; B7-V7; B8-V8)	
		TMM 4164AP-15	/TOSHIBA

EDINBURGH UNIVERSITY	ISSUE	No.	DATE	DRN.	CHK'D
	A	—			
DEPT.	B		2-6-83		
COMPUTER SCIENCE					
TITLE	COMPONENTS LIST				
MEMORY BOARD	A4/136				
	SHEET 3 OF 3				

Cct. Ref.	Qty.	Description	Supplier
		INTEGRATED CIRCUITS	
		74F SERIES	
F00	6		
F02	1		
F04	1		
F64	9		
F74	3		
F158	8		
F175	5		
F240	1		
F245	4		
F280	4		
F374	1		
FS21	2		
		74LS SERIES	
LS393	3		
		74S SERIES	
S38	1		
S260	2		
		MEMORY IC's	
		64K X 1 DRAMS 150ns	
72		MPD4164C-3 (PLASTIC) MPD4164D-3 (CERAMIC)	/NEC
		MB8264-15 (ALTERNATIVE)	/FUJITSU
		(AT LOCATIONS B5-V5; B6-V6; B7-V7; B8-V8)	
		MM4164P-2	HITACHI
		TMM4164AP-15	/TOSHIBA

EDINBURGH UNIVERSITY	ISSUE	No.	DATE	DRN.	CHK'D
	A	—			
DEPT. COMPUTER SCIENCE	B		2-6-83		
TITLE MEMORY BOARD		COMPONENTS LIST A4/136 SHEET 3 OF 3			

Item	Drwg No.	Description	Qty.
	A1/128 (5 SHEETS)	PRINTED CIRCUIT BOARD CSD128 ASHDOWN DESIGN SERVICES.	1
		SCOTCHFLEX CONNECTOR FIXINGS	
		M2.5 C'SK SCREWS X 10mm LONG	2
		M2.5 NUTS	2
		EJECTOR CLIPS (COLOUR NATURAL WHITE)	2
		CAMBION 415-7036-01-00-20 (INCLUDES PIVOTS)	
	A2/075	FRAME ASSEMBLY	
		BRIDGE BARS	2
		GUIDE BLOCK SUPPORT STRIP	1
		GUIDE BLOCK L.H.	1
		" " R.H.	1
		" " CENTRE	1
		BRIDGE BAR SPACER	8
		GUIDE BLOCK SCREWS (SLOTTED C'SK 6BA x 5/16")	6
		" " " (SLOTTED ROUND 6BA x 1/4")	8
		BRIDGE BAR SCREWS (SLOTTED ROUND 4BA x 1/2")	8
		SHAKEPROOF WASHER (4BA)	8
		" " (6BA)	8
		±12V REGULATORS FIXINGS	
		M3 SLOTTED C'SK X 8mm (5/16) LONG	2
		M3 WASHER	2
		M3 SHAKEPROOF WASHER	2
		M3 NUTS	2

EDINBURGH UNIVERSITY	ISSUE	No.	DATE	DRN.	CHK'D
	A	—	27-5-80	J.J.	
DEPT.					
COMPUTER SCIENCE					
TITLE	PARTS LIST				
INTERDATA EIA CONTROLLER	A4/128				
	SHEET 1 OF 1				

Cct. Ref.	Qty.	Description	Supplier
		74 SERIES TTL	
7400	2	A5, A6	
7402	1	A10	
7404	3	A19, A31, A60	
7411	1	A9	
7417	1	A3	
7432	1	A68	
7438	9	A7, A11, A12, A13, A14, A18, A46, A53, A55	
7438	1	A49 (NOT USED FOR OPTION 1)	
74123	1	A64	
		74H SERIES TTL	
74H04	1	A32	
		74 OR 74LS SERIES TTL	
X00	8	A1 A8 A15 A17 A35 A39 A40 A59	
X02	3	A16, A22, A37	
X04	2	A4, A20	
X08	4	A29, A52, A58, A65	
X14	1	A2	
X20	1	A41	
X30	2	A21, A28	
X32	3	A25, A45, A63	
X74	2	A38, A57	
X74	2	A54, A61 (NOT USED FOR OPTION 1)	
X76	3	A23, A24, A42	
		MISCELLANEOUS IC'S	
A47	1	AY-5-1013A/COM 2017HP (U.A.R.T.)	GEN. INST / RASTRA
A66	1	COM 5026/COM 5046 (BAUD RATE GEN.)	RASTRA.
A69,71	2	MC1489AL/SN75189AN (LINE RECEIVERS)	MOTOROLA / TEXAS
A72	1	MC1488BL/SN75188AN (LINE DRIVERS)	" "

EDINBURGH UNIVERSITY	ISSUE	No.	DATE	DRN.	CHK'D
	A	-	27-5-80	J.J.	
DEPT. COMPUTER SCIENCE					
TITLE INTERDATA EIA CONTROLLER.	COMPONENTS LIST A4/128				
	SHEET 1 OF 3				

Cct. Ref.	Qty.	Description	Supplier			
		IC SOCKETS				
	49	14 PIN CB4-14-02	TI SUPPLY			
	3	14 PIN " (NOT USED FOR OPTION 1)	"			
	4	16 PIN CB4-16-02	"			
	1	24 PIN CB4-24-02	"			
	1	40 PIN CB4-40-02	"			
		DIL SWITCHES				
A26, A27 A33, A34 A48, A67	6	SDCA (ERG 4-POLE CHANGEOVER)	FARNELL			
		CARRIER				
A70		24 PIN 702-3733-01-04-00 (STRAP AS REQUIRED)	CAMBION			
		POWER REGULATORS				
REG1	1	μA78M12UC (+12V)	FAIRCHILD / BARLEC			
REG2	1	μA79M12AUC (-12V)	" "			
		RESISTORS (U.O.S. ARE MR25 METAL FILM ±2% 0.4W)	FARNELL			
100R	1	R3				
470R	2	R1, R2				
390R	2	R6, R7				
1K	4	R4, R5, R18, R19				
10K	2	R8, R9				
15K NOM	0-8	R10-R17 (APPLICATION DEPENDENT)				
		CAPACITORS				
68pF	1	C4 POLYSTYRENE 113-257	R.S. COMPONENTS			
100pF	1	C1 POLYSTYRENE 113-263	"			
150pF	1	C3 " 113-279	"			
220pF	1	C5 " 113-285	"			
SELECT	0-8	C10-17 (NOT NORMALLY USED) POLYSTYRENE	"			
0.001μF	1-4	C6, (C7-9 NOT NORMALLY USED) POLYESTER 112-715	"			
EDINBURGH UNIVERSITY		ISSUE	No.	DATE	DRN.	CHK'D
		A	-	27-5-80	J.J.	
DEPT. COMPUTER SCIENCE						
TITLE INTERDATA EIA CONTROLLER.			COMPONENTS LIST A4/128 SHEET 2 OF 3			

Cct. Ref.	Qty.	Description	Supplier
0.01 μ F	7 ϕ	DECOUPLING CERAMIC PLATE 629 02103	MULLARD / FARNELL
0.1 μ F	1	C19 TANTALLUM BEAD ELECTROLYTIC 35V 100-894	DUBILIER / FARNELL
0.47 μ F	1	C18 " " " 35V 100-898	" "
1.0 μ F	1	C21 " " " 35V 100-900	" "
2.2 μ F	1	C20 " " " 25V 100-886	" "
22 μ F	4	C26-29 ELECTROLYTIC 10V 015-14229	MULLARD / FARNELL
SELECT	1	C2 (NOT NORMALLY USED) POLYSTYRENE	R. S. COMPONENTS
SELECT	4	C22-25 (NOT NORMALLY USED) AS REQUIRED	
0.1 μ F	4	DC1-4 TANTALLUM BEAD ELECTROLYTIC 35V 100-894	DUBILIER / FARNELL
X1	1	CRYSTAL (5.0688MHZ) CYSB	RASTRA
		ZENER DIODES (OPTION 2 ONLY)	
Z1-24	24	BZX61 12V 1.3W 282-707	R.S. COMPONENTS
		FUSES (OPTION 2 ONLY)	
F1-24	24	F290/0.06A	A.F. BULGIN
		INTERDATA MPX. BUS CONNECTOR	
	1	84-WAY 3-85927-4	AMP
		3Ms' SCOTCHFLEX CONNECTOR	
PL1	1	HEADER 16-WAY 83-21561E	VEROSPEED
SK1	1	SOCKET " 83-21563H	"
		SCOTCHFLEX FLAT CABLE (AS REQUIRED)	
		83-2156BK (SUPPLIED AS 3 METRE LENGTH)	VEROSPEED
		83-21589G (" " 30 " ")	"
		CONNECTOR (25-WAY D-TYPE)	
	1	DB25P (PLUG) 6286R	CANNON / ITT
	OR 1	DB25S (SOCKET) 6291D	CANNON / ITT
		PANEL SCREW KIT FOR 25-WAY D-TYPE CONNECTOR	
		D 20418-2 STOCK N° 6255A	ITT CANNON
		(WILL MOUNT 1 D-TYPE CONNECTOR)	

EDINBURGH UNIVERSITY	ISSUE	No.	DATE	DRN.	CHK'D
	A	-	27-5-80	J.J.	
DEPT.	COMPUTER SCIENCE				
TITLE	INTERDATA EIA CONTROLLER				
COMPONENTS LIST					A4/128
SHEET 3 OF 3					

Item	Drwg No.	Description	Qty.
1	A1/A2/081	PDP-11 LINK CONTROL (COMPONENT LAYOUT)	
	+COMP. LIST		
2		INSULATING COVER (FOR CRYSTAL) RUBY STAINED MICA (0.1 - 0.2mm THK) 1" x 1" MICALECTRIC LTD, PONTYPRIDD, MID. GLAMORGAN.	1
3		HANDLE (COLOUR GREEN) SUPPLIED BY VERO ELECTRONICS PART N° 10036	2
4		RIVETS $\frac{4}{16}$ " N° 11 ORDINARY OVAL HEAD ALUMINIUM SEMI-TUBULAR THE BIFURCATED & TUBULAR RIVET CO. LTD.	4
5		CABLE TIE R.S. COMPONENTS 543-42B	1
		CO-AX CABLE 75JL R.S. COMPONENTS UNIRADIO 202	
6		BLACK 388-164	2.5 METRES
7		WHITE 388-186	2.5 METRES
		BNC CONNECTOR	
8		CO-AX CRIMP PLUG SUHNER ELECTRONICS 11-BNC-50-3-4	2
		SLEEVES	
9		PLASTIC (WHITE) SUHNER ELECTRONICS 78Z-9-3-2	1
10		PLASTIC (BLACK) " " 78Z-10-3-2	1

EDINBURGH UNIVERSITY	ISSUE	No.	DATE	DRN.	CHK'D
	A	-	30-7-79	J.J.	
DEPT.	COMPUTER SCIENCE				
TITLE	PDP-11 LINK CONTROL MODULE H014 (PARTS ASSEMBLY)				PARTS LIST
					A4/121
					SHEET 1 OF 1

Cct. Ref.	Qty.	Description	Supplier
	1	PRINTED CIRCUIT BOARD A1/2/079	ASHDOWN DESIGN
7400	3	IC 7, 15, 30	STD. CHIPS
7402	3	IC 9, 36, 57	
7408	3	IC 13, 37, 38	
7425	2	IC 59, 60	
7428	1	IC 42	
7432	1	IC 18	
7437	2	IC 45, 71	
7474	5	IC, 8, 20, 24, 33, 35	
7493A	2	IC 3, 39	
7496	2	IC 2, 6	
74LS00	3	IC, 56, 65, 73	
74LS02	3	IC 63, 68, 76	
74LS04	2	IC 19, 21	
74LS08	2	IC 46, 66	
74LS74	5	IC 31, 47, 48, 67, 75	
74LS93	1	IC 27	
74LS160	1	IC 5	
74H00	2	IC 32, 58	
74H04	2	IC 41, 72	
74H11	1	IC 14	
74H74	2	IC 25, 74	
74S03	2	IC 34, 40	
74S08	3	IC 26, 43, 44	

EDINBURGH UNIVERSITY	ISSUE	No.	DATE	DRN.	CHK'D
	A	—	30-7-79	J.J.	
DEPT.					
COMPUTER SCIENCE					
TITLE	COMPONENTS LIST				
PDP-11 LINK CONTROL (COMPONENT LAYOUT PCB B)	A4/081				
	SHEET 1 OF 4				

Cct. Ref.	Qty.	Description	Supplier
N8242A	3	IC 51,52,53	SIGNETICS
N8262A	2	IC 12,29	"
N8273B	1	IC 23	"
D58836	2	IC 61,64	NAT. SEMI.
D58837	5	IC 1,11,49,50,54	" "
8881	8	IC 17,22,28,55,62,69,70,77	SIGNETICS / LOCK
8T13B	1	IC 10	SIGNETICS
8T14B	1	IC 16	"
		IC SOCKETS	
	65	C84-14-Ø2 (14-PIN)	TEXAS
	12	C84-16-Ø2 (16-PIN)	"
		COMPONENT CARRIER	
	1	702-3728-01-03 (16-PIN) Pds ^m IC4	CAMBION
		CRYSTAL	
	1	FS 5901/11 16.896 MHZ	CATHODEON

EDINBURGH UNIVERSITY	ISSUE	No.	DATE	DRN.	CHK'D
	A	-	30-7-79	J.S.	
DEPT.	COMPUTER SCIENCE				
TITLE	PDP-11 LINK CONTROL (COMPONENT LAYOUT PCB B)				
			COMPONENTS LIST		
			A4/081		
			SHEET 2 OF 4		

Cct. Ref.	Qty.	Description	Supplier
		RESISTORS	
		MR25 METAL FILM $\pm 2\%$ 0.4WATT	MULLARD/FARNEILL
		MR30 " " " 0.5WATT	" "
R1	1	1K MR25	
-			
R4	1	1K MR25	
R5	1	75R MR30	
R6	1	75R MR30	
R7	1	1K MR25	
R8	1	SELECT VALUE (SEE DRWG A1/079 SHEET 5)	
		NOMINAL VALUE 68K MR25	
R9-13	5	1K MR25	
R14	1	47K MR25	
R15-19	5	1K MR25	
R20	1	100R MR25	
R21-29	9	1K MR25	
R30-31	2	390R MR25	
R32-33	2	1K MR25	
R34	1	47R MR30	
R35	1	1K MR25	
R36	1	180R MR25	
R37	1	1K MR25	
R38	1	47R MR30	
R39	1	180R MR25	
-			
-			
R50	1	6K8 MR25	

EDINBURGH UNIVERSITY	ISSUE	No.	DATE	DRN.	CHK'D
	A	-	30-7-79	J.J.	
DEPT.	COMPUTER SCIENCE				
TITLE	PDP-11 LINK CONTROL (COMPONENT LAYOUT PCB B)				
			COMPONENTS LIST A4/081 SHEET 3 OF 4		

Cct. Ref.	Qty.	Description	Supplier
C1	1	100 μ F 100 V Electrolytic Cap	RS
C3	1	100 μ F 25 V " "	RS
C2	1	.01 μ F Disc Cap	RS
R1,2,4	3	1K6 6 WATT WW Welwyn W22	Fornell
R3	1	330R 5 WATT " "	Fornell
R5	1	1K2 $\frac{1}{4}$ W	
R6	1	620R "	
R7	1	10K "	
R8	1	100K "	
R9	1	5K6 "	
R10	1	330R "	
R11	1	560R "	
R12,13	2	1K "	
D1,2,3,4	4	10D4 1 Amp 400 Volt Sil Rect	ITT
D5	1	12 Volt Zener BZX61	RS
TR3,4,5,6	4	ZTX 300 NPN TRANS	Ferranti
TR1,2	2	BF 259 400V Trans	RS
O11,2	2	TIL 107 Opto-Isolator	TI
	1	Minibox $1\frac{3}{8} \times 2\frac{1}{8} \times 3\frac{1}{8}$ 275 22C	ITT
	1	Key SW BPO 1102 ITT 28226C	ITT
		PYETMC S527616 L4C/L4C	
	1	2.5 in x .5 in x $\frac{1}{16}$ Alum strips	
	9	PIDG Eaton Rec. #110 Red 140822-1	Ampliversal
	1	PIDG 6 BA Tag Red	"
	7	6 in lengths of 7/0.2mm PVC wire	RS
	1	45 in length STD MULTI 12 WAY	RS
	2	3 m lengths STD MULTI 8 WAY	RS
	3 in	Large Shrinkable Sleeving	RS
	6 in	Medium " "	RS
	2	4 BA Nylon Nuts	RS
	2	6 BA 1 in Screws, washers, shakeproof nuts	RS
	2	.7 in spacers	

EDINBURGH UNIVERSITY

DEPT.

Computer Science

TITLE

Switched 20mA Olivetti Interface.

ISSUE	No.	DATE	DRN.	CHK'D
A	-			

COMPONENTS LIST

A4/052

SHEET OF

Cct. Ref.	Qty.	Description	Supplier
1,5,6 8,15,17 36,37	8	7400 Quad 2 input NAND	
10,16,23	3	7402 Quad 2 input NOR	
4,20 26,27 31,35	6	7404 Hex invertor	
9	1	7408 Quad 2 input AND	
2	1	7414 Hex Schmitt Invertor	
3	1	7417 O.C. Buffer	
38	1	7420 4 input NAND	
22,30	2	7430 8 input NAND	
7,11,12 13,14 18,34	7	7438 Quad 2 input NAND (OC Buffer)	
24,25 33,39	4	7476 Dual J-K	
	31	0.01 μ F Capacitors 50 μ F Tantalum (Distributed)	
	2	200 pF	
	2	470 Ω resistors $\frac{1}{4}$ watt	
	5	1k resistors "	
	2	3k3 resistors "	

EDINBURGH UNIVERSITY

DEPT.

Computer Science

TITLE

Interdata AA link Interface
(AA link control)

ISSUE No. DATE DRN. CHK'D

A

—

DATE

DRN.

CHK'D

COMPONENTS LIST

A4/033

SHEET 1 OF 3

Cct. Ref.	Qty.	Description	Supplier
50,51 56,62	4	7400 Quad 2 input Nand	
55,58	2	7402 Quad 2 input Nor	
52,57	2	7404 Hex invertor	
53	1	7408 Quad 2 input AND	
60,61	2	7410 3 input Nand	
57	1	7430 8 input Nand	
64	1	7437 Quad 2 input Nand Buffer	
42,43 48,49 54	5	7474 Dual D-type	
44,45 65,68 69	5	7493 ÷ 16 Counter	
66	1	8713	Signetics
59	1	8714	Signetics
47	1	74164 8 Bit Serial in SR	
46	1	74165 8 Bit Serial out SR	
	1	16 Pin DIL Socket	
	1	4.224 MHz CRYSTAL OSC. Type FS5901/11	Cathodeon

EDINBURGH UNIVERSITY

DEPT.

Computer Science

TITLE INTERDATA AA LINK INTERFACE
(AA Link Trans/Rec)

ISSUE	No.	DATE	DRN.	CHK'D
A	-			

COMPONENTS LIST

A4/033

SHEET 2 OF 3

Cct. Ref.	Qty.	Description	Supplier
	2	75Ω .05 W Oxide Resistor	RS
	1	47K 1/4 watt	
	1	470K 1/4 "	
	1	1K 1/4 Watt	
	1	1μF 6.3V Axial lead Tantal Cap	
	28	101μF Decoupling Caps.	
	4	ZTX 500 PNP Transistors	Ferranti
	2	ZTX 300 NPN Transistors	Ferranti
	1	Amp 3-85927-4 Connector	

EDINBURGH UNIVERSITY

DEPT.

Computer Science

TITLE

Interdata AA Link Interface
(AA Link Trans/Rec)

ISSUE	No.	DATE	DRN.	CHK'D
A	-			

COMPONENTS LIST

A4/033

SHEET 3 OF 3

Cct. Ref.	Qty.	Description	Supplier
7400	1	QUAD 2-INPUT NAND	
7404	8	HEX INVERTER	
7408	4	QUAD 2-INPUT AND	
7432	2	QUAD 2-INPUT OR	
7474	4	DUAL D-TYPE FLIP-FLOP	
7475	1	QUAD DISTRABLE LATCH	
7485	2	4-BIT COMPARATOR	STANDARD
7486	1	QUAD 2-INPUT XOR	CHIPS.
74100	1	DUAL 4-BIT BISTABLE LATCH	
74123	2	MONOSTABLE MULTIVIBRATOR	
74150	2	16 TO 1 DATA SELECTOR	
74157	13	4 FROM 8 MULTIPLEXOR	
74161	2	SYNCHRONOUS 4-BIT COUNTER	
74193	4	SYNCHRONOUS 4-BIT UP/DOWN COUNTER	
745201	8	256 x 1 RANDOM ACCESS MEMORY	READ INSTRUMENTS.
DM8575AAA/N	1	HOLLERITH TO ASCII CODE CONVERTER	ATLANTIC COMPONENTS.
EM6100PE	4	32 x 8 READ ONLY MEMORY (IRSIATL)	MANUFACTURER: INTEL
		(PROGRAM FOR ROMS ATTACHED).	SUPPLIER: TRANSCONTINENTAL ELECTRONICS.
		A TOTAL OF 4 EM6100PE ROMS:	
		1 AS PER PROGRAM 1	
		1 AS PER PROGRAM 2	
		1 AS PER PROGRAM 3	
		1 AS PER PROGRAM 4	

EDINBURGH UNIVERSITY	ISSUE	No.	DATE	DRN.	CHK'D
	A	-			
DEPT.	COMPUTER SCIENCE				
TITLE	MDS 6042		COMPONENTS LIST		
	CARD READER INTERFACE		A4/10		
			SHEET OF		

Cct. Ref.	Qty.	Description	Supplier
	1	W998 Blank Module	D.E.C.
	1	Terminal strip	
		Resistors	
		Type-Carbon	
		TDL. - $\pm 10\%$	
		$\frac{1}{4}W$ unless otherwise stated	
		Value - OHMS unless otherwise stated	
R1	1	330	
R2	1	1.8K	
R3	1	1.8K 0.125W	
R4-R5	2	1.0K 0.500W	
R6 -R7	2	390 0.500W	
R8	1	3.3K 0.125W	
R9	1	3.9K	
R10-R13	4	1.8K 0.500W	
		Transistors	
T1	1	Ferranti BFS60	
T2	1	Ferranti ZTX500	
		Diodes	
D1-D2	2	Texas 1N 914A	
D8	1	International Rectifier 1N 4735A 6.2V	

EDINBURGH UNIVERSITY	ISSUE	No.	DATE	DRN.	CHK'D
	A	—	25.7.71	J.J.	
DEPT. COMPUTER SCIENCE					
TITLE TELETYPE INTERFACE (CCITT OR EIA CONNECTION).	COMPONENTS LIST				
	A4/010/02				
	SHEET 1 OF 1				

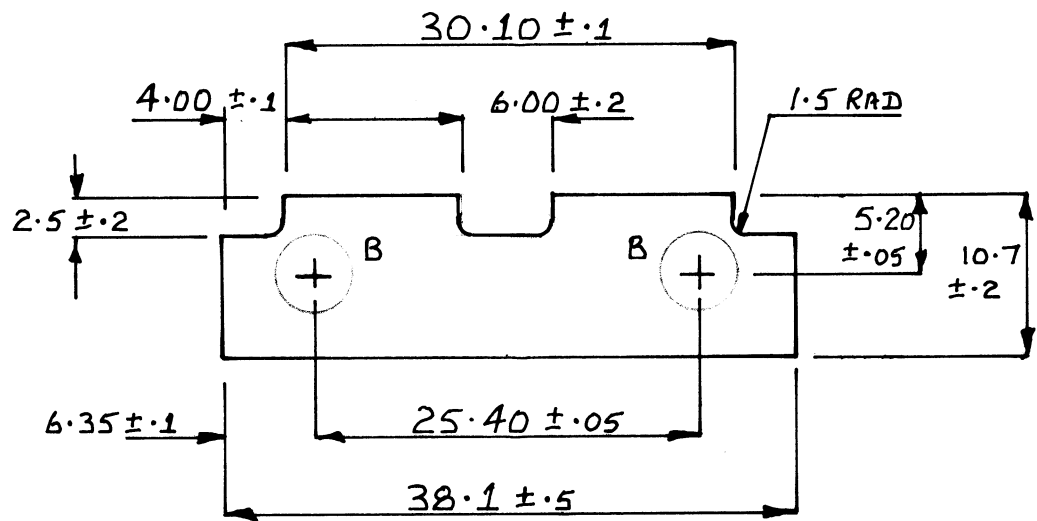
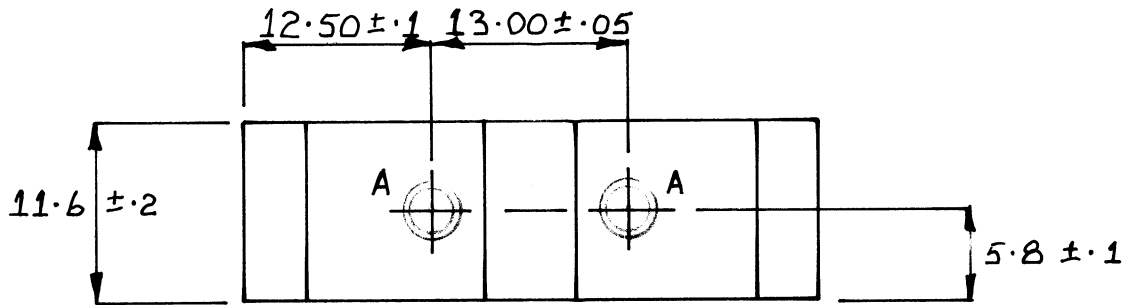

'B' HOLES 5.2 DRILL

'A' HOLES TAP M4

SCALE 2:1

MAT. TUFNOL		TREATMENT			FINISH				
EDINBURGH UNIVERSITY					ISSUE	No.	DATE	DRN.	CHK'D
					A	-	11-2-83	J.J	
DEPT. COMPUTER SCIENCE									
TITLE GUIDE BLOCK (ETHERNET TAP)					DRWG No. A4/145 SHEET 1 OF 1				

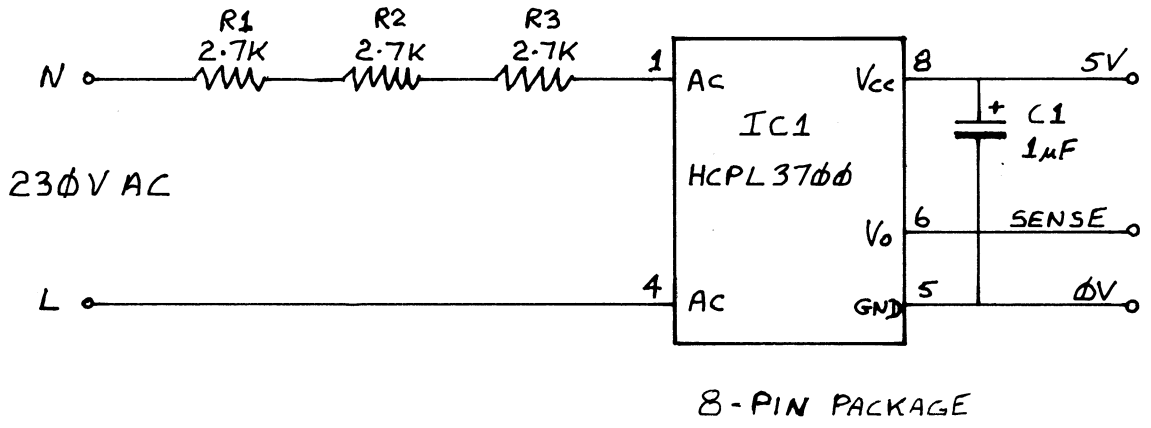

2. R1/R2/R3 ARE 2.5W AND MOUNTED 5mm ABOVE BOARD.

NOTES 1. PCB REF CSD139

MAT.	TREATMENT	FINISH				
EDINBURGH UNIVERSITY		ISSUE	No.	DATE	DRN.	CHK'D
		A	—	25-11-82	J.J.	
DEPT. COMPUTER SCIENCE						
TITLE <u>MAINS CLOCK SENSE BOARD</u>			DRWG No. A4/139 SHEET 1 OF 1			

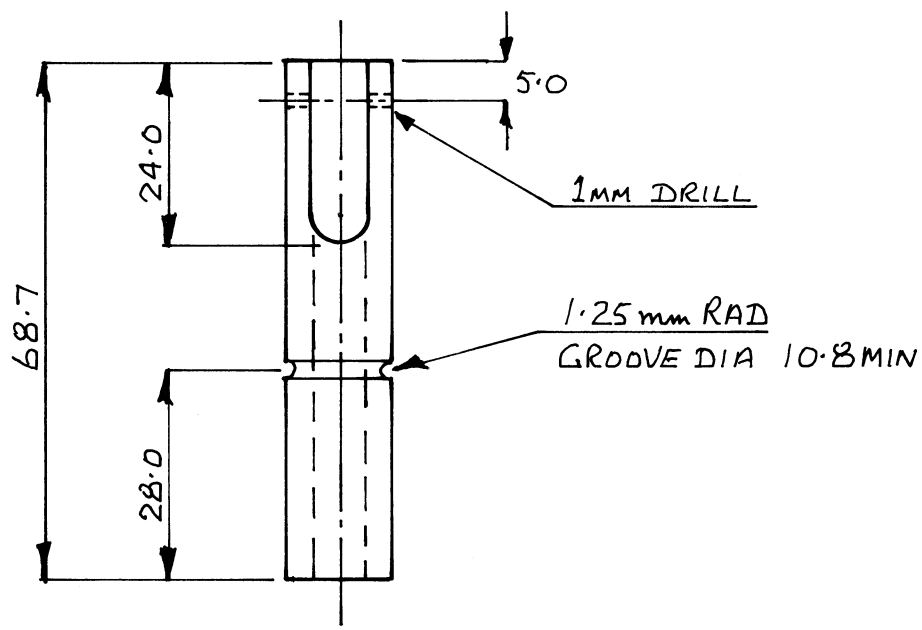
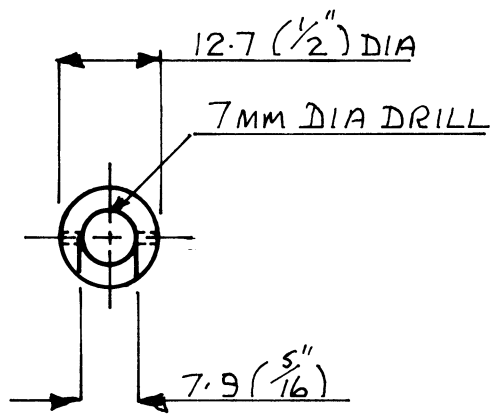

TOLERANCES : ± 0.2 U.O.S.

MAT.		TREATMENT		FINISH				
EDINBURGH UNIVERSITY				ISSUE	No.	DATE	DRN.	CHK'D
				A	-	18.9.80	J.J.	
DEPT. COMPUTER SCIENCE								
TITLE PILLAR (TYPE B)				DRWG No. A4/130				
				SHEET 3 OF				

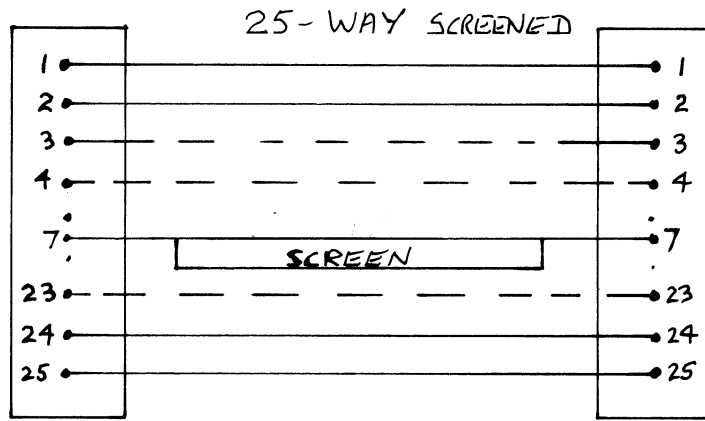

CONNECTOR 'A'

CONNECTOR 'B'

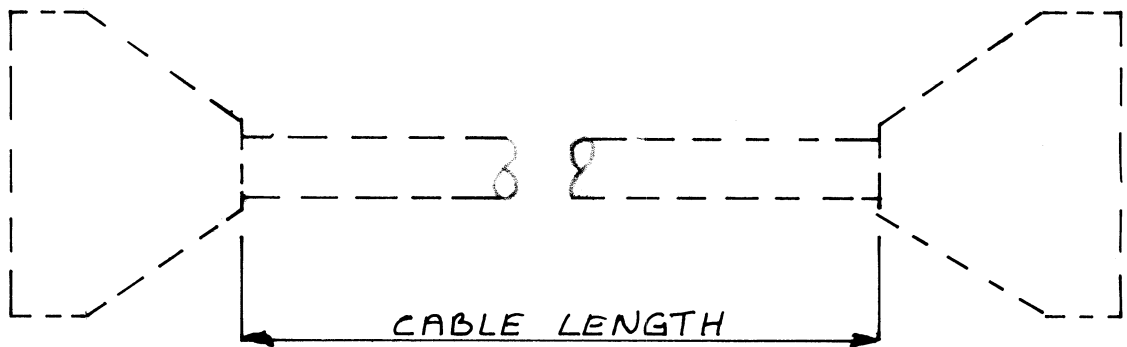

CONNECTOR 'A'	25 WAY 'D' TYPE	SOCKET
CONNECTOR 'B'	25 WAY 'D' TYPE	PLUG

CABLE LENGTH =

Nº OFF =

MAT.		TREATMENT			FINISH				
EDINBURGH UNIVERSITY					ISSUE	No.	DATE	DRN.	CHK'D
					A	-	15/2/80	J.J.	
DEPT.		COMPUTER SCIENCE							
TITLE					DRWG No.				
CABLE ASSEMBLY					A4/125				
					SHEET 1 OF 1				

25-WAY SCREENED

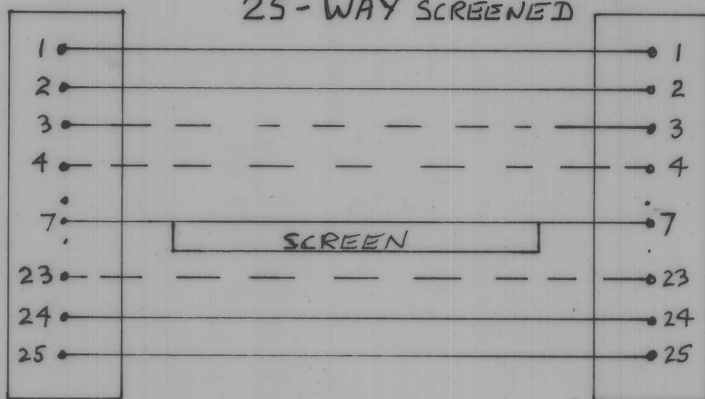

CONNECTOR 'A'

CONNECTOR 'B'

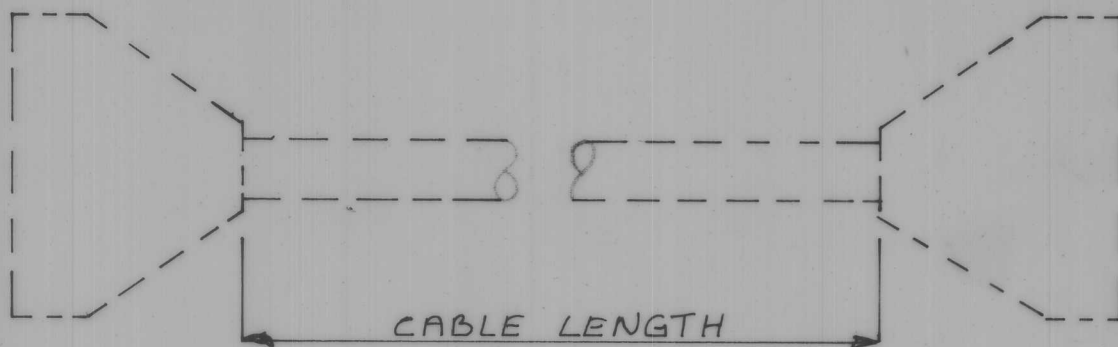

CONNECTOR 'A'	25 WAY 'D' TYPE PLUG
CONNECTOR 'B'	25 WAY 'D' TYPE PLUG

CABLE LENGTH =

Nº OFF =

MAT.		TREATMENT			FINISH				
EDINBURGH UNIVERSITY					ISSUE	No.	DATE	DRN.	CHK'D
					A	-	15/2/80	J.J.	
DEPT.		COMPUTER SCIENCE							
TITLE					DRWG No.				
CABLE ASSEMBLY					A4/126				
					SHEET 1 OF 1				

25-WAY SCREENED

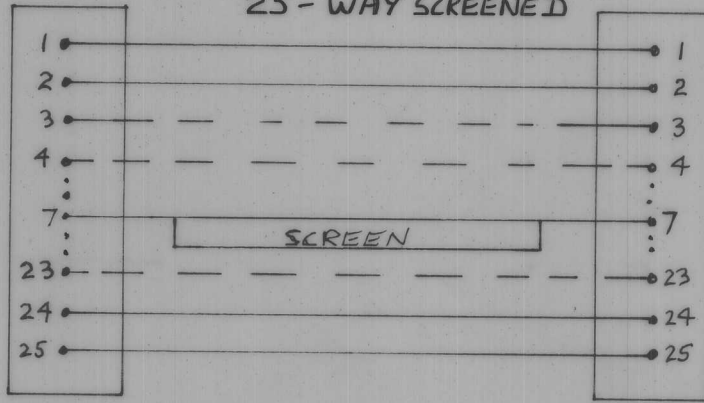

CONNECTOR 'A'

CONNECTOR 'B'

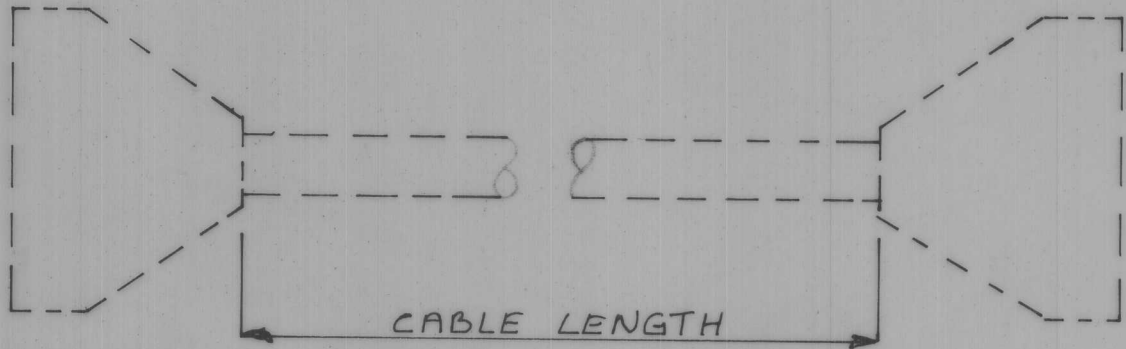

CONNECTOR 'A'	25 WAY 'D' TYPE	SOCKET
CONNECTOR 'B'	25 WAY 'D' TYPE	SOCKET

CABLE LENGTH =

Nº OFF =

MAT.		TREATMENT			FINISH			
EDINBURGH UNIVERSITY				ISSUE	No.	DATE	DRN.	CHK'D
				A	-	15/2/80	J.J.	
DEPT.		COMPUTER SCIENCE						
TITLE					DRWG No.			
CABLE ASSEMBLY					A4/127			
					SHEET 1 OF 1			

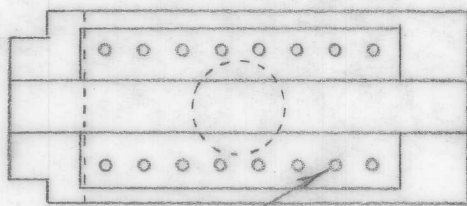
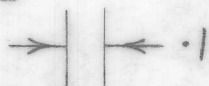
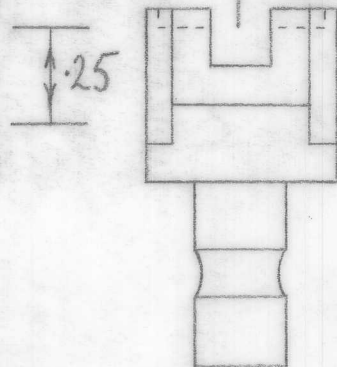
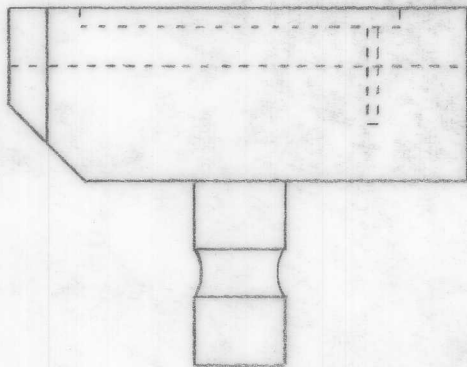
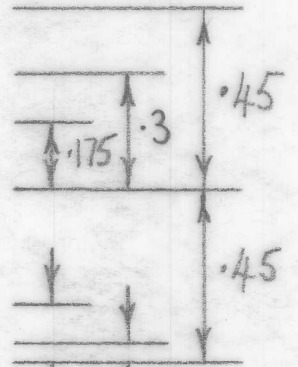
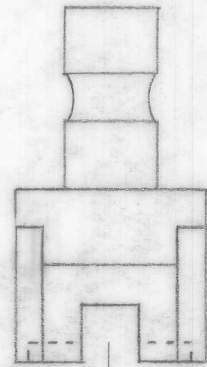
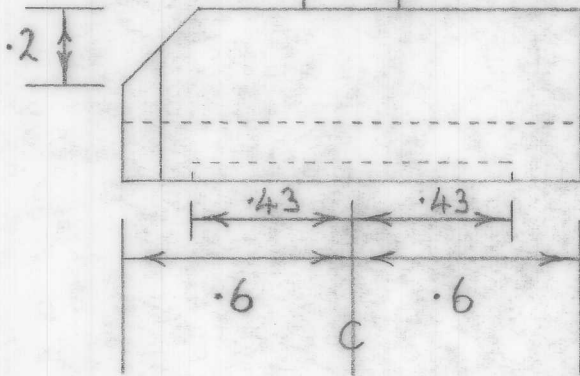
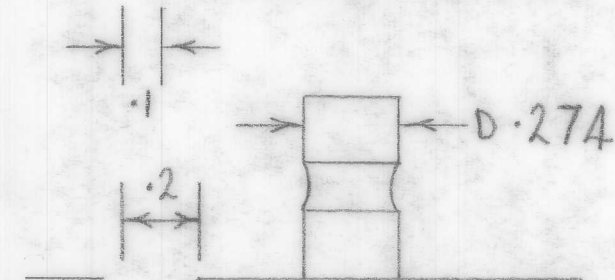
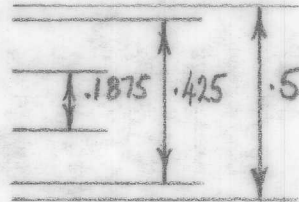
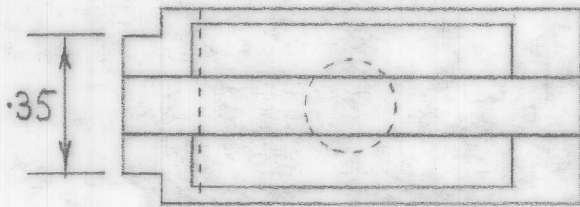

HOLES .030 DIAM.

BOTH PARTS ARE THE SAME EXCEPT FOR THE MATRIX OF .030 DIAM. HOLES

MAT. MS or BRASS or DURAL		TREATMENT		FINISH				
EDINBURGH UNIVERSITY				ISSUE	No.	DATE	DRN.	CHK'D
				A	-	30/05/79	P.S.L	
DEPT. COMPUTER SCIENCE								
TITLE 3M DIL CRIMP TOOLS				DRWG No. A4/98				
				SHEET / OF /				



TRANCHANT PROGRAMMING CENTER
HAMPTON, MIDDLESEX, ENGLAND



Tomorrow's Electronics Today

For Memories think
TRANCHANT

IM5610

IM5600 PROGRAMMING TRUTH TABLE

Company _____

Address _____

Post Code _____

Phone _____ **IM5600** 32x8 ROM "1"= high, "0"=low

IM5610

DATE	Page 2 of 4
CUSTOMER P.O. No.	
CUSTOMER PRINT OR I.D. No.	
PACKAGE	TEMP. RANGE

ENTER DESIRED CODE FOR EACH INPUT ADDRESS: A0 IS LEAST SIGNIFICANT BIT OF ADDRESS

PROGRAM 2

ADDRESS INPUTS						DATA OUTPUTS							
PIN NUMBER					Word Number	PIN NUMBERS							
14	13	12	11	10		9	7	6	5	4	3	2	1
CODE					Word Number	CODE							
A4	A3	A2	A1	A0		O8	O7	O6	O5	O4	O3	O2	O1
0	0	0	0	0	0	0	0	0	0	0	0	0	0
0	0	0	0	1	1	0	1	0	1	0	0	0	0
0	0	0	1	0	2	0	0	0	0	0	1	0	0
0	0	0	1	1	3	0	1	0	0	1	0	0	0
0	0	1	0	0	4	0	0	0	0	0	0	0	0
0	0	1	0	1	5	0	0	0	0	0	0	0	0
0	0	1	1	0	6	0	0	0	0	0	0	0	0
0	0	1	1	1	7	0	0	0	0	0	0	0	0
0	1	0	0	0	8	0	0	0	0	0	0	0	0
0	1	0	0	1	9	0	0	0	0	0	0	0	0
0	1	0	1	0	10	0	0	0	0	0	0	0	0
0	1	0	1	1	11	0	0	0	0	0	0	0	0
0	1	1	0	0	12	0	0	0	0	0	0	0	0
0	1	1	0	1	13	0	0	0	0	0	0	0	0
0	1	1	1	0	14	0	0	0	0	0	0	0	0
0	1	1	1	1	15	0	0	0	0	0	0	0	0
1	0	0	0	0	16	0	0	1	0	0	0	0	0
1	0	0	0	1	17	0	0	0	0	0	0	0	0
1	0	0	1	0	18	0	0	0	0	0	0	0	0
1	0	0	1	1	19	0	0	0	0	0	0	0	0
1	0	1	0	0	20	0	0	0	0	0	0	0	0
1	0	1	0	1	21	0	0	0	0	0	0	0	0
1	0	1	1	0	22	0	0	0	0	0	0	0	0
1	0	1	1	1	23	0	0	0	0	0	0	0	0
1	1	0	0	0	24	0	0	0	0	1	0	1	0
1	1	0	0	1	25	0	0	0	0	0	0	0	0
1	1	0	1	0	26	0	0	0	0	0	0	0	0
1	1	0	1	1	27	0	0	0	0	0	0	0	0
1	1	1	0	0	28	0	0	0	0	0	0	0	0
1	1	1	0	1	29	0	0	0	0	0	0	0	0
1	1	1	1	0	30	0	0	0	0	0	0	0	0
1	1	1	1	1	31	0	0	0	0	0	0	0	0



TRANCHANT PROGRAMMING CENTER
HAMPTON, MIDDLESEX, ENGLAND



Tomorrow's Electronics Today

For Memories think
TRANCHANT

IM5610
~~IM5600~~ PROGRAMMING TRUTH TABLE

Company _____

Address _____

_____ Post Code _____

Phone _____ ~~IM5600~~ 32x8 ROM "1" = high, "0" = low

IM5610

ENTER DESIRED CODE FOR EACH INPUT ADDRESS: A0 IS LEAST SIGNIFICANT BIT OF ADDRESS

DATE _____	Page 3 of A
CUSTOMER P.O. No. _____	
CUSTOMER PRINT OR I.D. No. _____	
PACKAGE _____	TEMP. RANGE _____

PROGRAM 3

ADDRESS INPUTS						DATA OUTPUTS							
PIN NUMBER					Word Number	PIN NUMBERS							
14	13	12	11	10		9	7	6	5	4	3	2	1
CODE						CODE							
A4	A3	A2	A1	A0		O ₈	O ₇	O ₆	O ₅	O ₄	O ₃	O ₂	O ₁
0	0	0	0	0	0	0	0	0	0	0	0	0	0
0	0	0	0	1	1	0	1	1	0	1	0	0	0
0	0	0	1	0	2	1	1	0	0	0	0	0	1
0	0	0	1	1	3	0	1	1	0	0	0	0	0
0	0	1	0	0	4	0	0	0	0	0	1	0	0
0	0	1	0	1	5	0	0	0	1	0	0	0	0
0	0	1	1	0	6	0	0	0	0	0	0	0	0
0	0	1	1	1	7	1	0	0	0	0	0	0	0
0	1	0	0	0	8	0	0	0	0	0	0	0	0
0	1	0	0	1	9	0	0	0	0	0	0	1	0
0	1	0	1	0	10	0	0	0	0	0	0	0	0
0	1	0	1	1	11	1	0	0	0	0	0	1	0
0	1	1	0	0	12	0	0	0	0	0	0	1	0
0	1	1	0	1	13	0	0	0	0	0	0	0	0
0	1	1	1	0	14	0	0	0	0	0	1	0	0
0	1	1	1	1	15	0	0	1	0	0	0	0	0
1	0	0	0	0	16	1	0	0	0	0	0	0	0
1	0	0	0	1	17	0	0	0	0	0	1	0	0
1	0	0	1	0	18	0	0	0	0	1	0	0	0
1	0	0	1	1	19	1	0	0	0	0	0	0	0
1	0	1	0	0	20	0	0	0	0	0	0	0	0
1	0	1	0	1	21	0	0	0	0	0	0	0	0
1	0	1	1	0	22	0	0	0	1	0	0	1	0
1	0	1	1	1	23	0	0	0	0	0	0	0	0
1	1	0	0	0	24	1	1	0	0	0	0	0	0
1	1	0	0	1	25	0	0	0	0	0	0	0	0
1	1	0	1	0	26	0	0	0	0	0	0	0	0
1	1	0	1	1	27	0	0	0	0	0	0	0	0
1	1	1	0	0	28	0	0	0	0	0	0	0	0
1	1	1	0	1	29	0	0	0	0	0	0	0	0
1	1	1	1	0	30	0	0	0	0	0	0	0	0
1	1	1	1	1	31	0	0	0	0	0	0	0	0



TRANCHANT PROGRAMMING CENTER
HAMPTON, MIDDLESEX, ENGLAND



Tomorrow's Electronics Today

For Memories think
TRANCHANT

IM5610

~~IM5600~~ PROGRAMMING TRUTH TABLE

Company _____

Address _____

Post Code _____

Phone _____ ~~IM5600~~ 32x8 ROM "1"=high, "0"=low

IM5610

ENTER DESIRED CODE FOR EACH INPUT ADDRESS: A0 IS LEAST SIGNIFICANT BIT OF ADDRESS

DATE	Page <u>4</u> of <u>4</u>
CUSTOMER P.O. No.	
CUSTOMER PRINT OR I.D. No.	
PACKAGE	TEMP. RANGE

PROGRAM 4

ADDRESS INPUTS						DATA OUTPUTS							
PIN NUMBER					Word Number	PIN NUMBERS							
14	13	12	11	10		9	7	6	5	4	3	2	1
CODE						CODE							
A ₄	A ₃	A ₂	A ₁	A ₀		O ₈	O ₇	O ₆	O ₅	O ₄	O ₃	O ₂	O ₁
0	0	0	0	0	0	1	0	0	0	0	0	0	0
0	0	0	0	1	1	0	0	0	0	0	0	0	0
0	0	0	1	0	2	1	0	0	0	0	0	0	0
0	0	0	1	1	3	0	0	0	0	0	0	0	0
0	0	1	0	0	4	0	0	0	0	0	0	1	1
0	0	1	0	1	5	0	0	0	0	0	0	0	0
0	0	1	1	0	6	0	0	0	0	0	0	0	0
0	0	1	1	1	7	0	1	0	0	0	0	1	0
0	1	0	0	0	8	0	0	0	0	0	0	0	0
0	1	0	0	1	9	0	0	0	0	0	0	0	0
0	1	0	1	0	10	0	0	0	1	0	0	0	0
0	1	0	1	1	11	0	0	0	0	0	1	1	0
0	1	1	0	0	12	0	0	0	0	0	0	0	0
0	1	1	0	1	13	0	0	0	1	0	0	0	0
0	1	1	1	0	14	0	0	0	0	0	0	0	0
0	1	1	1	1	15	0	0	0	0	0	0	0	0
1	0	0	0	0	16	0	0	0	1	1	0	0	0
1	0	0	0	1	17	0	0	0	0	0	0	0	0
1	0	0	1	0	18	0	0	0	0	0	0	0	0
1	0	0	1	1	19	0	0	0	1	1	0	0	0
1	0	1	0	0	20	0	0	1	0	0	0	0	0
1	0	1	0	1	21	0	0	0	0	0	0	0	0
1	0	1	1	0	22	0	0	0	0	0	0	0	0
1	0	1	1	1	23	0	0	0	0	0	0	0	0
1	1	0	0	0	24	0	0	0	0	0	0	0	0
1	1	0	0	1	25	0	0	1	0	0	0	0	0
1	1	0	1	0	26	0	0	0	0	0	0	0	0
1	1	0	1	1	27	0	0	0	0	0	0	0	0
1	1	1	0	0	28	0	0	0	0	0	0	0	0
1	1	1	0	1	29	0	0	0	0	0	0	0	0
1	1	1	1	0	30	0	0	0	0	0	0	0	0
1	1	1	1	1	31	0	0	0	0	0	0	0	0

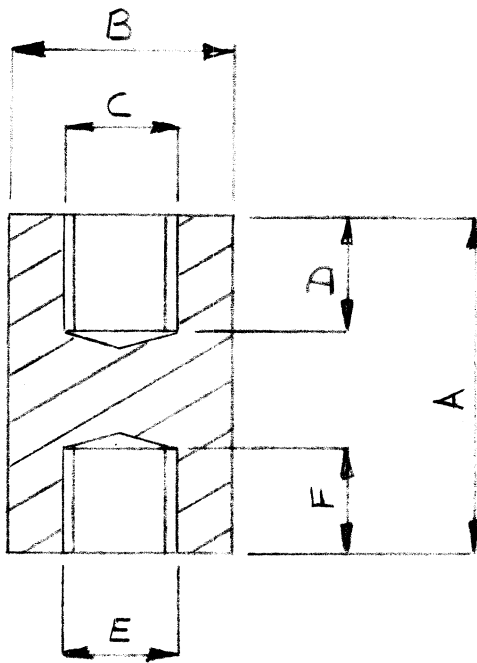

REF	N ^o OFF	DIMENSION					
		A	B	C	D	E	F

NOT TO SCALE

MAT.		TREATMENT			FINISH				
EDINBURGH UNIVERSITY					ISSUE	No.	DATE	DRN.	CHK'D
					A	—			
DEPT. COMPUTER SCIENCE									
TITLE TAPPED SPACER					DRWG No. A4/047 SHEET 1 OF 1				

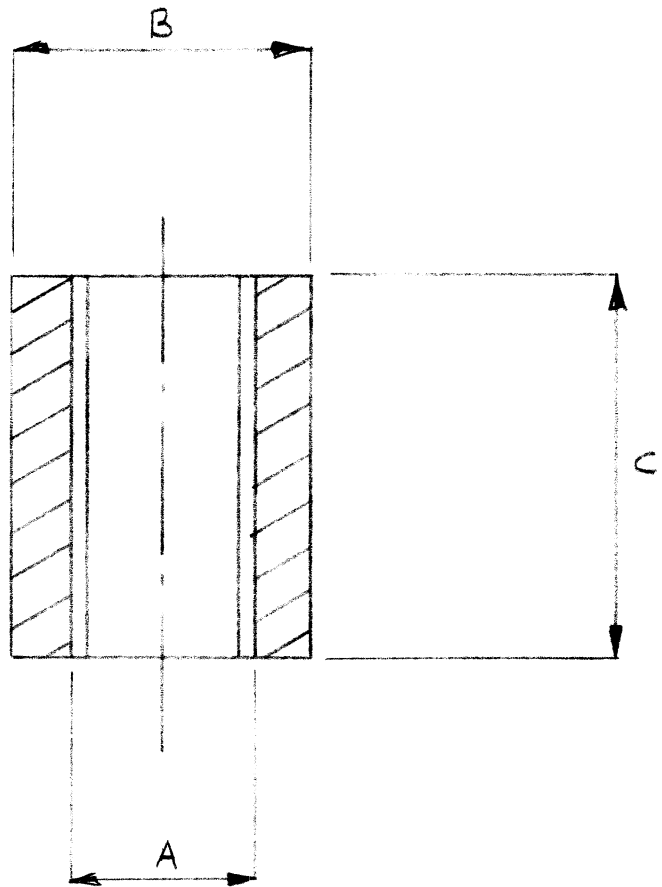

REF	N ^o OFF	DIMENSION		
		A	B	C

NOT TO SCALE

MAT.		TREATMENT			FINISH				
EDINBURGH UNIVERSITY					ISSUE	No.	DATE	DRN.	CHK'D
					A	—			
DEPT. COMPUTER SCIENCE									
TITLE SPACER					DRWG No. A4/046				
					SHEET 1 OF 1				

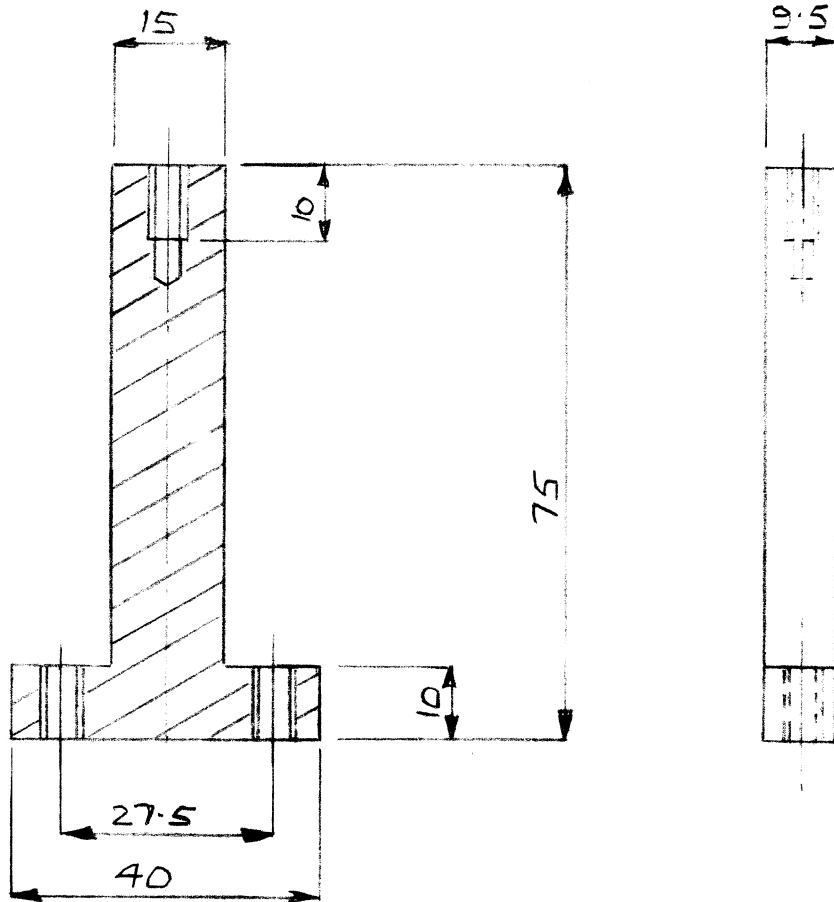

Holes TAPPED 2BA

DIMENSIONS IN MM U.O.S

MAT. MILD STEEL		TREATMENT			FINISH			
EDINBURGH UNIVERSITY				ISSUE	No.	DATE	DRN.	CHK'D
				A	-		J.J	
DEPT. COMPUTER SCIENCE								
TITLE SOCKET PANEL SUPPORT					DRWG No. A4/034			
					SHEET 1 OF 1			

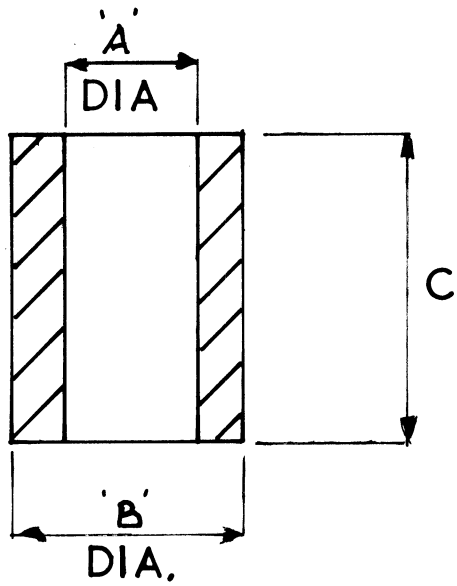

REF	N° OFF	DIMENSION		
		A	B	C

NOT TO SCALE

MAT.		TREATMENT			FINISH			
EDINBURGH UNIVERSITY				ISSUE	No.	DATE	DRN.	CHK'D
				A	—	13/4/12	IWMI	
DEPT. COMPUTER SCIENCE								
TITLE SPACER				DRWG No. A4/O10/O4				
				SHEET 1 OF 1				

CARD READER INTERFACE / MOHAWK READER CABLE CONNS

24 PIN
COMPONENT CARRIER

AMP
24 PIN

AMP
60 PIN

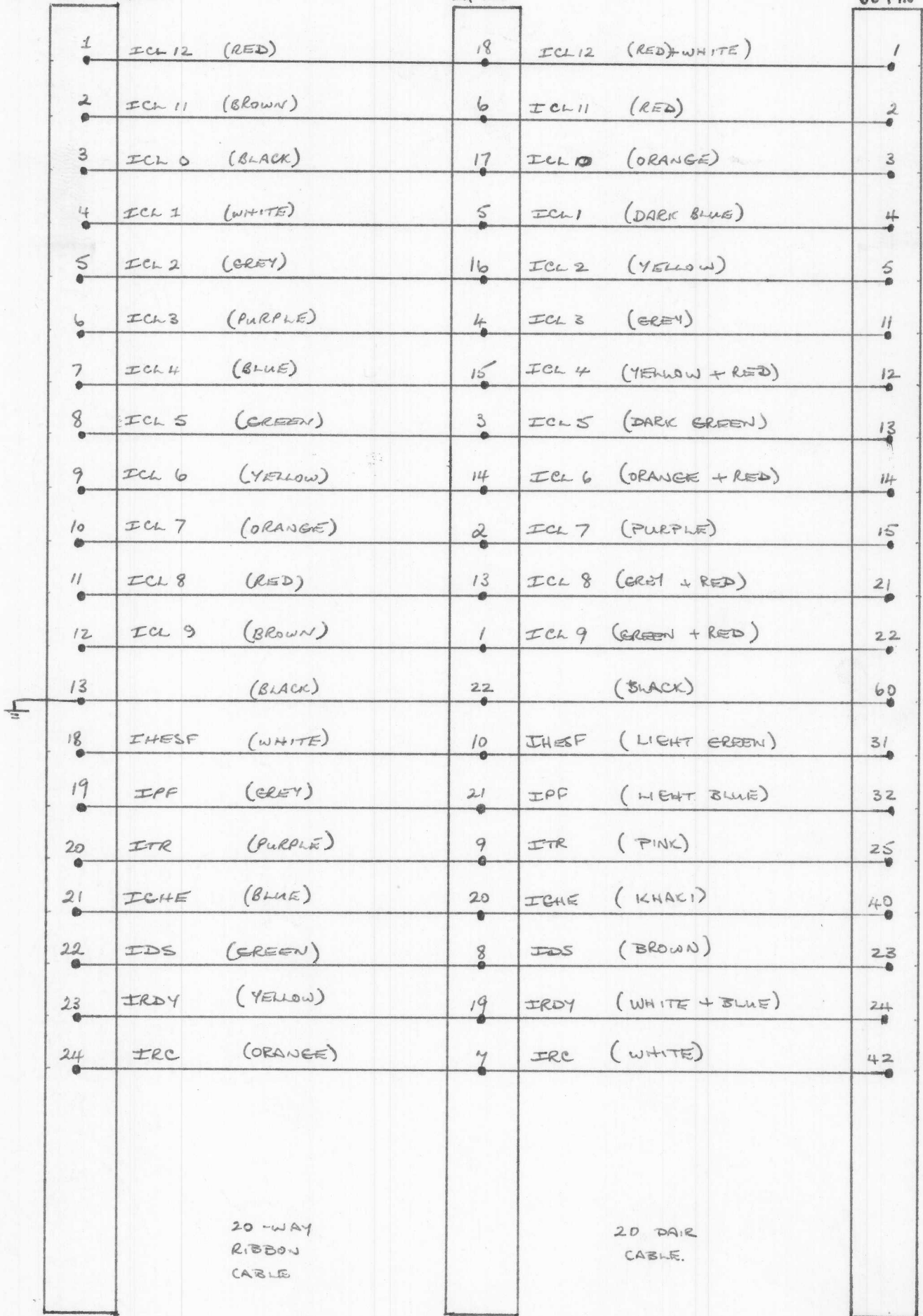

20-WAY
RIBBON
CABLE

20 PAIR
CABLE.

INPUT
MODULE

INTERFACE
BACK PANEL

CARD
READER

Option Switches Interfacing Logic

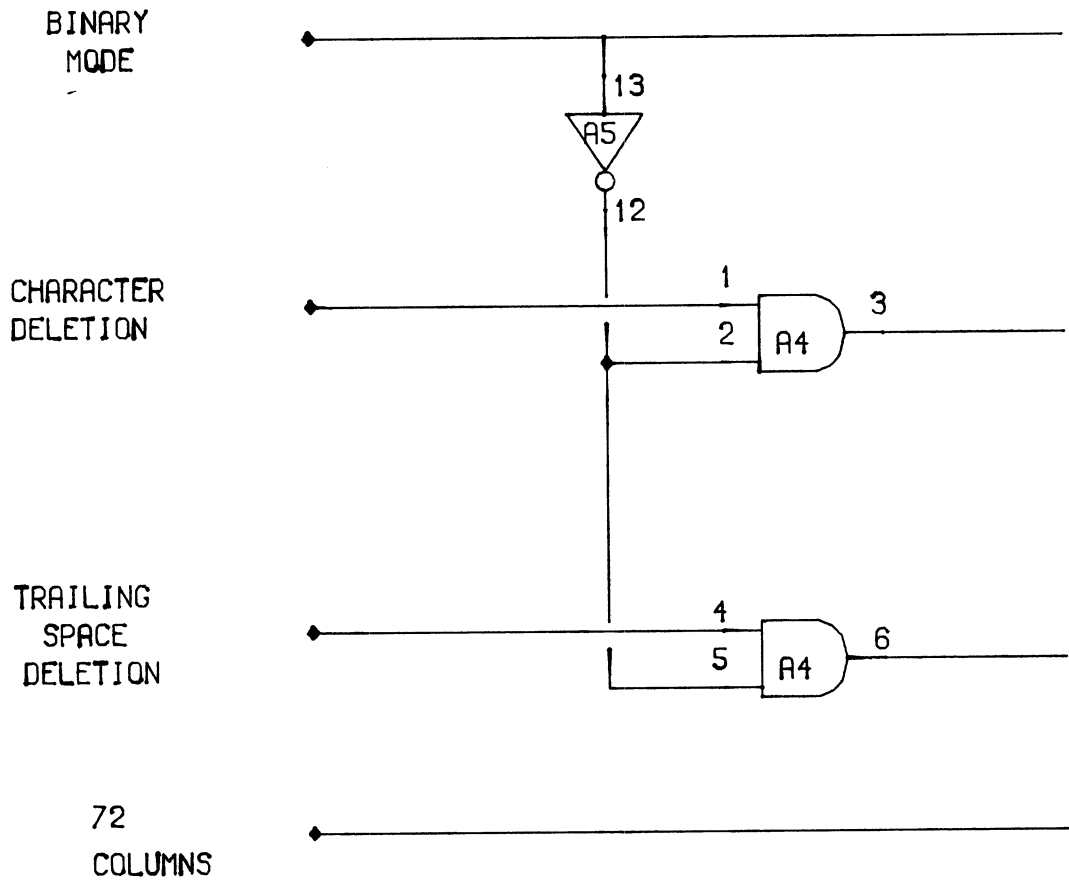

MAT.	TREATMENT	FINISH				
EDINBURGH UNIVERSITY		ISSUE	NO.	DATE	DRN.	CHKD
		A	-			
DEPT. OPTION SW INTERFACE						
TITLE MDS 6042 CARD READER INTERFACE			DRWG NO. A4/08 SHEET 8 OF 9			

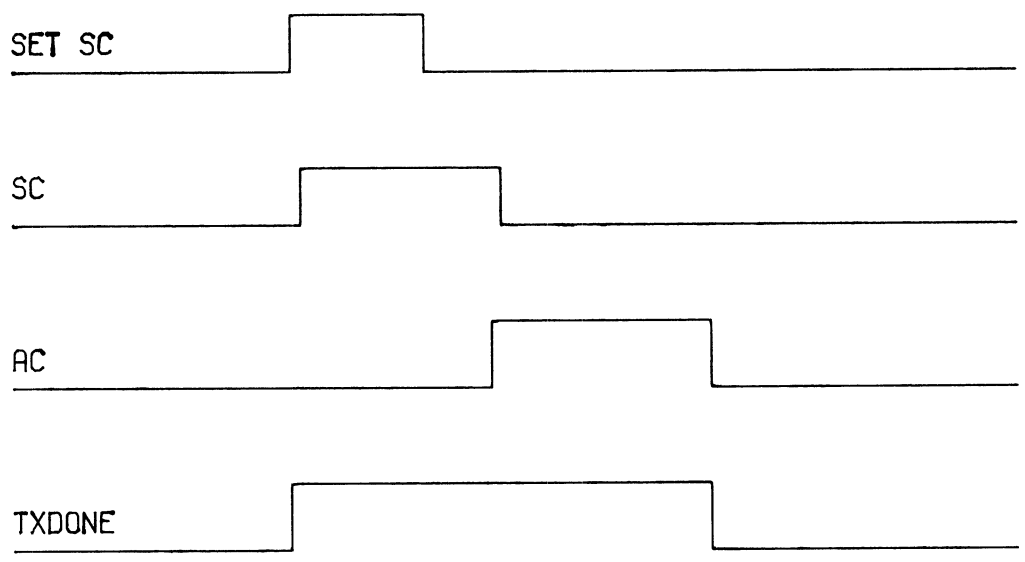
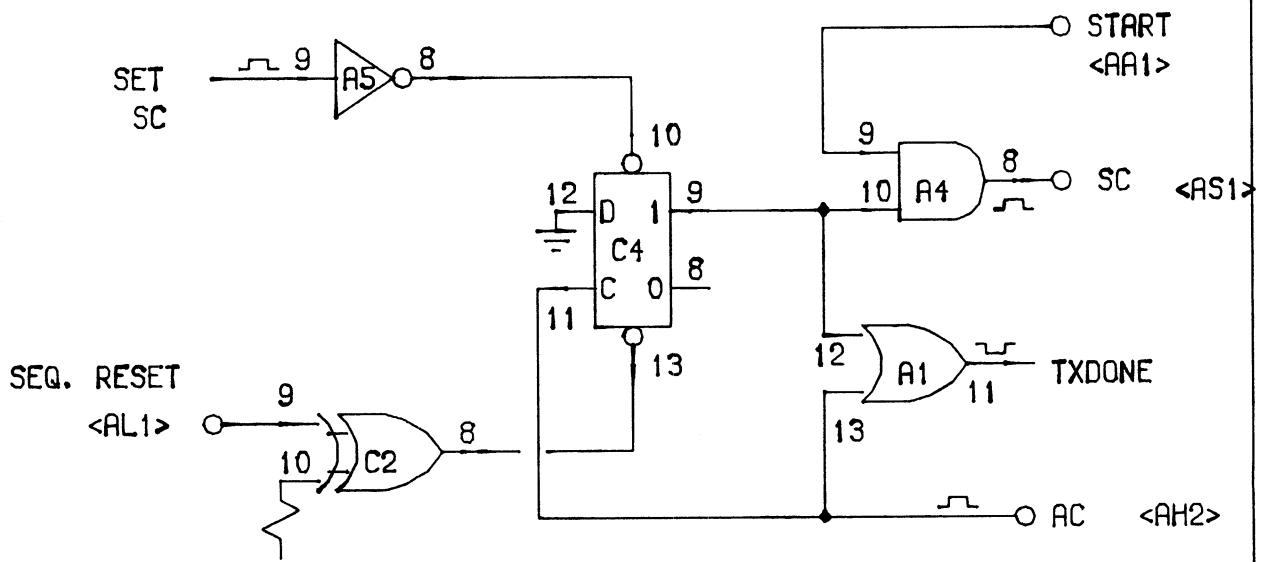

Link Synchronization - Timing diagram

MAT.		TREATMENT			FINISH		
EDINBURGH UNIVERSITY		ISSUE	NO.	DATE	DRN.	CHKD	
		A	-				
DEPT.		LINK SYNC					
TITLE		MDS 6042			DRWG NO.		
CARD READER INTERFACE.					A4/07		
		SHEET 7 OF 9					

THIRD ANGLE PROJECTION

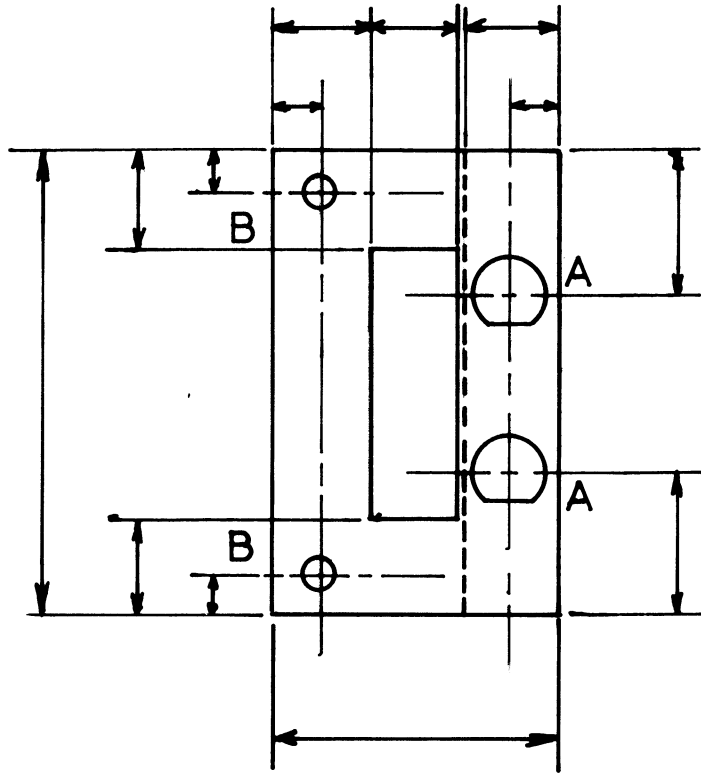
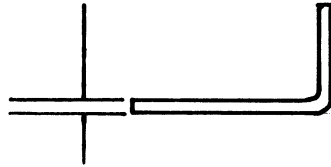

Scale: 1:1

MAT.	ALUMINIUM	TREATMENT	_____		FINISH	_____		
EDINBURGH UNIVERSITY		ISSUE	No.	DATE	DRN.	CHK'D		
		A	—					
DEPT.	COMPUTER	SCIENCE						
TITLE	CARD HANDLE		DRWG No.					
			A4/005/2			SHEET 1 OF 1		

THIRD ANGLE PROJECTION.

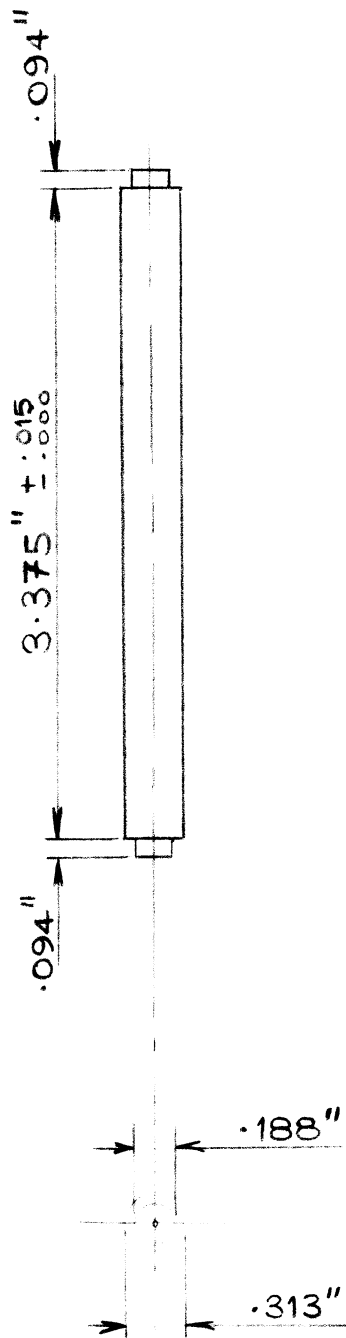

TOLERANCE :- ± .015 U.O.S.

SCALE :- 1/1.

MAT. PERSPEX.		TREATMENT			FINISH			
EDINBURGH UNIVERSITY				ISSUE	No.	DATE	DRN.	CHK'D
				A	-	12-10-71	KAMC	
DEPT. COMPUTER SCIENCE.								
TITLE SPACER FOR FORSTER CARD READER					DRWG No. A4/004/01			
					SHEET 1 OF 1			

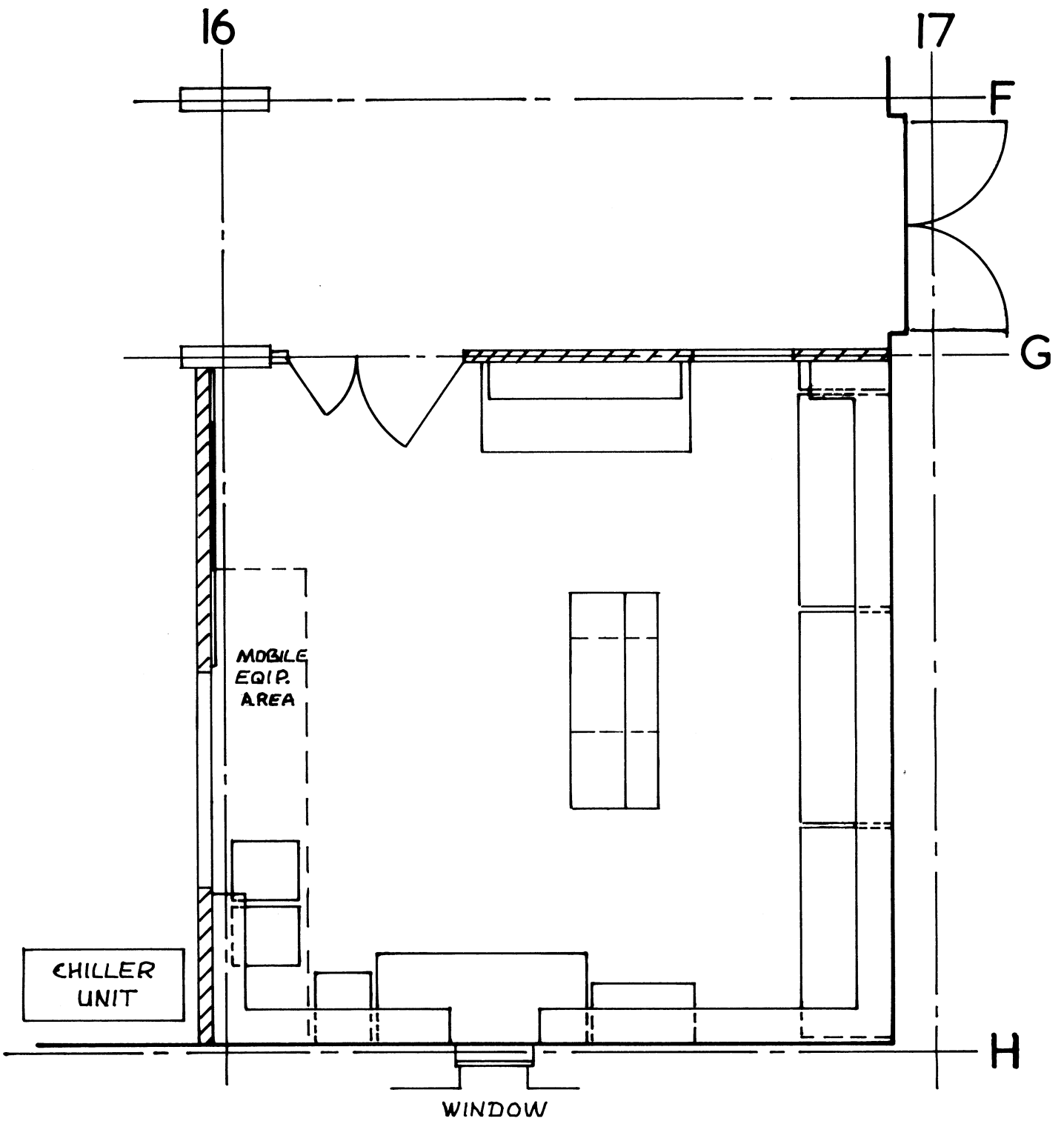

FIG

SCALE 1/2" = 2ft

FIG

SCALE $\frac{1}{2}'' = 2\text{ft}$

25mm

5mm

NOTES

1. SHEET SIZE A4
2. BORDER LINES SHOULD BE SLIGHTLY THICKER THAN THE OTHER FORMAT LINES
3. PRINT ON UNDERSIDE
4. ALL CHARACTERS, UNLESS SHOWN OTHERWISE, TO BE 2mm HIGH.
5. DIMENSIONED IN MILLIMETRES
6. THE LETTERS IN 'EDINBURGH UNIVERSITY' SHOULD BE SLIGHTLY THICKER THAN THOSE OF THE OTHER BOX NAMES.

MAT.	TREATMENT	FINISH				
EDINBURGH UNIVERSITY	A	ISSUE	N ^o	DATE	DRN.	CHK'D
			-			
DEPT.						
TITLE	DRWG N ^o A4/ 4mm SHEET OF					