

Vectrex[™]
GRAPHIC COMPUTER SYSTEM

LIGHTS



GCE[™]
A Milton Bradley Company

GCE[™]
A Milton Bradley Company

PART NO. 140016—0024 ART REV A

© General Consumer Electronics, Inc. 1983, Santa Monica, CA 90401. All Rights Reserved.
A copyright protection is claimed on the program stored within the cartridge.



90 Day Limited Warranty

This Video Game Cartridge is warranted by General Consumer Electronics, Inc. to the original consumer purchaser in the U.S.A. for a period of 90 days from the original purchase date under normal use and service against defective workmanship and materials. ANY IMPLIED WARRANTIES ARE ALSO LIMITED IN DURATION TO THE NINETY (90) DAY PERIOD FROM THE ORIGINAL PURCHASE DATE. SOME STATES DO NOT ALLOW LIMITATIONS ON HOW LONG AN IMPLIED WARRANTY LASTS. SO THE ABOVE LIMITATION MAY NOT APPLY TO YOU.

This warranty is void if the GCE Video Game Cartridge has been damaged by accident, unreasonable use, neglect, misuse, abuse, improper service, modification, subject to commercial use or other causes not arising out of defects in workmanship or materials and is limited to electronic and mechanical parts contained in the cartridge.

GENERAL CONSUMER ELECTRONICS, INC. SHALL NOT BE LIABLE FOR LOSS OF USE OF THE VIDEO GAME CARTRIDGE OR OTHER INCIDENTAL OR CONSEQUENTIAL COSTS, EXPENSES OR DAMAGES INCURRED BY THE PURCHASER RESULTING FROM BREACH OF ANY EXPRESS OR IMPLIED WARRANTIES ON THE VIDEO GAME CARTRIDGE. SOME STATES DO NOT ALLOW THE EXCLUSION OR LIMITATION OF INCIDENTAL OR CONSEQUENTIAL DAMAGES. SO THE ABOVE LIMITATION OR EXCLUSION MAY NOT APPLY TO YOU.

During the warranty period, if found to be defective due to workmanship or materials, the GCE Video Game Cartridge will at the option of General Consumer Electronics, Inc. be repaired or replaced with a new or reconditioned GCE Video Game Cartridge without charge for parts or labor when returned by Purchaser with proof of purchase date, shipped prepaid to General Consumer Electronics, Inc. at the following address:

General Consumer Electronics, Inc.

233 Wilshire Boulevard

Santa Monica, California 90401

In the event that your GCE Video Game Cartridge is replaced, the warranty on the replacement will be ninety (90) days from the date of its return to you.

Score Record

Date	Name	Score
_____	_____	_____
_____	_____	_____
_____	_____	_____
_____	_____	_____
_____	_____	_____
_____	_____	_____
_____	_____	_____
_____	_____	_____
_____	_____	_____
_____	_____	_____
_____	_____	_____
_____	_____	_____
_____	_____	_____
_____	_____	_____
_____	_____	_____
_____	_____	_____
_____	_____	_____
_____	_____	_____
_____	_____	_____
_____	_____	_____
_____	_____	_____
_____	_____	_____

MAIL PLANE is a new way for you to learn and have fun at the same time! With Mail Plane you can discover North American geography by planning your daily mail delivery: choose your own path through many cities, load your packages on board, and fly from one destination to another.
Take control of your plane altitude, speed, gasoline check and refill, and watch out for raging storms on your way! Will you make your daily delivery on time?

Setting Up

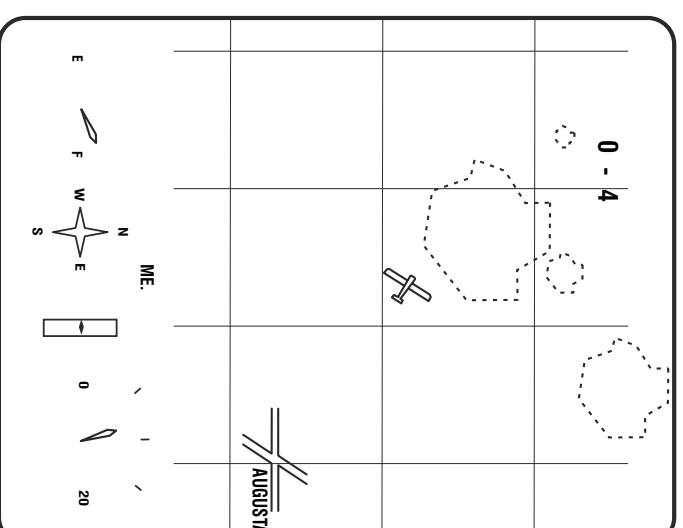
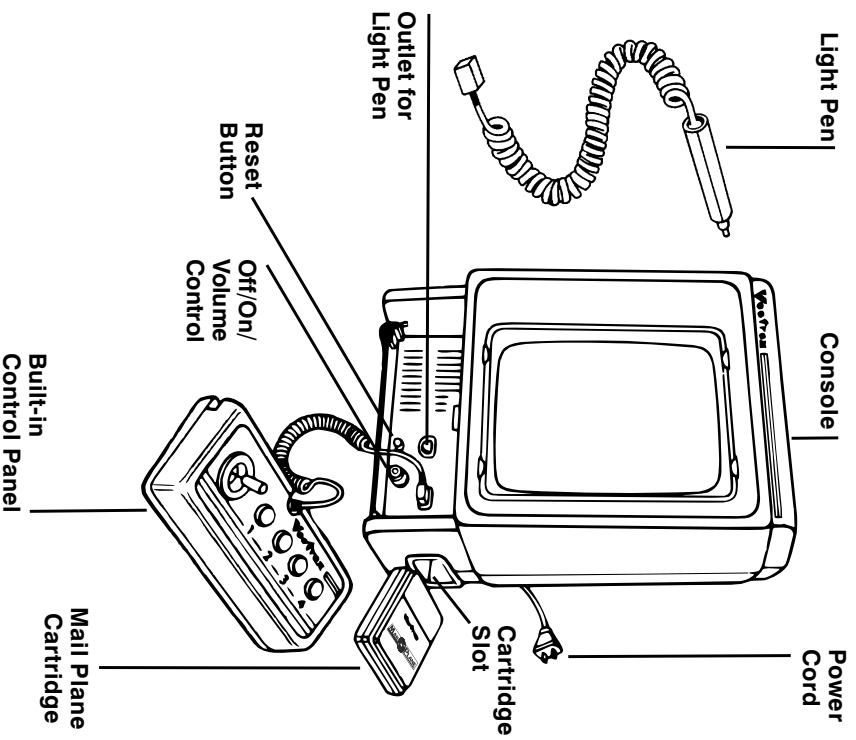

Good luck, Mail Planer!

"... Sometimes, after a hundred miles of steppes as desolate as the sea, he encountered a lonely farm-house that seemed to be sailing backwards from him in a great prairie sea, with its freight of human lives; and he saluted with his wings this passing ship. ..."

Antoine de Saint-Exupéry

IN THE AIR!

Step 4: Go deliver avoiding obstacles

And now the way to deliver is up to you! Following your chosen path, you must take control and watch your gasoline level, altitude, route, raging storms, and dangerous moving clouds!

CONTROLS:

You can adjust your plane's altitude, turn left and right as you prefer, but be careful not to go too low or the plane will crash into the ground!

CLOUDS:

The plane will get bigger or smaller according to your flight altitude. Clouds will affect your plane depending on your size. Make sure to be either bigger or smaller than the clouds you pass by, to avoid getting struck by lightning, or you'll crash in seconds.

LANDING:

Once you are close to a destination you have to land the plane in the city. When you are close to it, lower your plane until the landing screen appears for the mail delivery procedure.

GASOLINE:

When you land in a city, gasoline will be restored automatically. Only your flying skills will allow you to land on time before running out of gasoline.

MAP CHECK:

You can press Button 3 anytime to see the map.

Setting Up

- Make sure the console power cord is plugged into a 120 volt AC 60 cycle electrical outlet.
- Check to be sure the plug for the built-in control panel is firmly seated in the control panel outlet on the right.
- Plug the Vectrex Light Pen into the outlet marked '2nd Player' (to the left of where the control panel is plugged in).
- **MAKE SURE THE CONSOLE IS TURNED OFF BEFORE INSERTING THE CARTRIDGE.** Insert the MAIL PLANE cartridge into the cartridge slot with the label side up. Be sure it is firmly inserted to the guideline marked on the cartridge.
- Turn the OFF/ON/VOLUME CONTROL to the ON position (clockwise). You will see the Vectrex title for a few seconds, then the MAIL PLANE title, followed by the Menu.
- Adjust the volume control to the desired listening level.
- **IMPORTANT**—Adjust the BRIGHTNESS CONTROL (on back of console) so that the white dot in the center of the screen just barely disappears. If the brightness is too dim, the Light Pen will not provide maximum performance

BEFORE YOU BEGIN...

Mail Plane's features make it one of the most amazing mail delivery games available today so before we go into all the details, here's a simple summary of the main steps:

1. Choose the flying route
2. Load the mail onto the plane
3. Make the plane airborne
4. Go deliver avoiding obstacles

Now let's take these basic steps and explain them in more detail ...

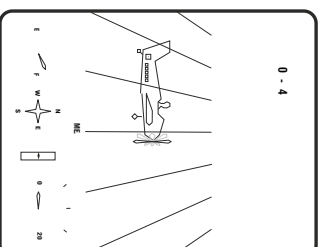

Push Button 4 on your built-in control panel in order to accelerate your plane.

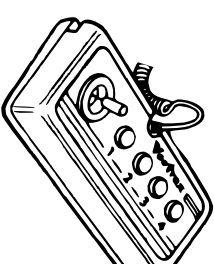

While holding Button 4, push down the control stick on the control panel in order to give altitude to your plane.

Keep holding and your plane will take off.

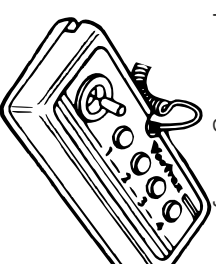

You can also use your Light Pen instead of the control stick on the control panel in order to regulate your altitude in much more precise way.

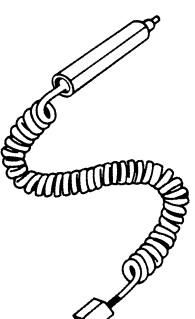

TAKE OFF!

Step 3: Make the plane airborne

You are ready to make your plane airborne and start delivery, but first examine the following control explanation:

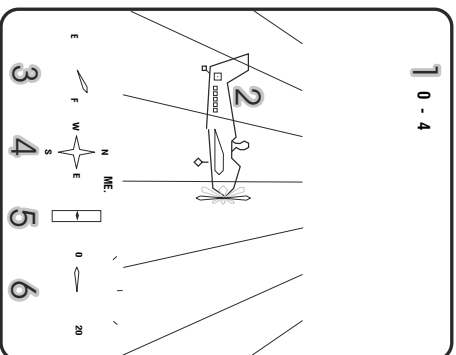

- 1: Score - Lives
- 2: Your plane with mail loaded on board
- 3: Gasoline Level
- 4: N S W E compass
- 5: Pitch elevator
- 6: Air speed indicator (mph)

FLYING ROUTE

Step 1: Choose the flying route

When the game starts, you have to choose a flying route for your mail to be delivered.

In the first stage there are eleven cities to fly through:

- AUGUSTA (ME)
- MONTPELIER (VT)
- CONCORD (NH)
- BOSTON (MA)
- PROVIDENCE (RI)
- HARTFORD (CT)
- ALBANY (NY)
- HARRISBURG (PA)
- TRENTON (NJ)
- ANNAPOLIS (MD)
- DOVER (DE)

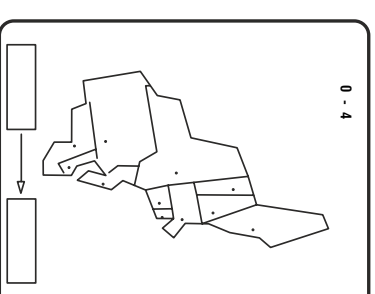

You can freely choose to fly from one city to another, in the order you prefer. However, due to the gasoline availability, there are some flight time restrictions. If the journey between two cities is too long, you won't be able to reach your destination, so plan your route carefully!

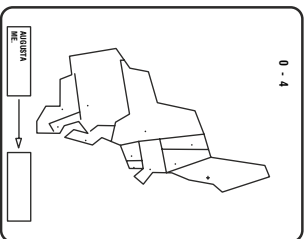

Take your VECTREX Light Pen and point it at one desired city, for example, AUGUSTA (ME). This city will be your starting point.

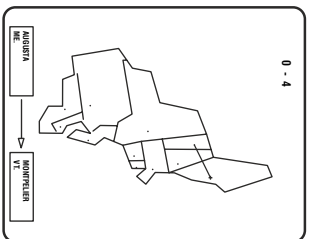

Choose your first destination, the nearer the better. The information box below the map will show your departure and destination cities (AUGUSTA -> MONTPELIER)

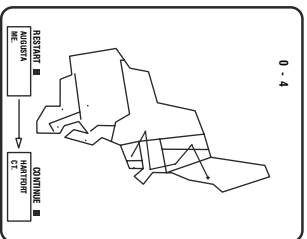

Repeat for further destinations. Once you have chosen your flying path, with a maximum of six destinations in total, point your Light Pen at the CONTINUE box to proceed.

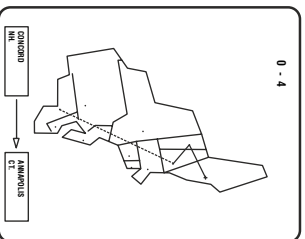

WARNING!
Long routes between cities are marked by a dashed line. It's not going to be easy to reach this destination, as "gasoline" is a limited resource!

GETTING YOUR MAIL ONBOARD

Step 2: Load the mail onto the plane

After you have chosen your flying path, the airplane is nearly ready to go. Before doing so, you have to check the mail and put it in the cabin.

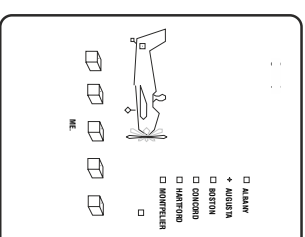

Your departure city is flagged by a '+', sign, there's no mail delivery at this point.

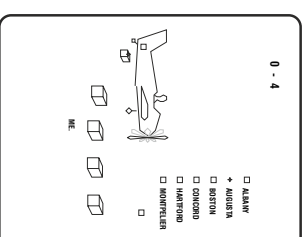

Take your Light Pen and point it at a package below the plane, drag it into the cabin to load on board. When you pick up a package, the top row on the right side of the screen will show you to which city the package has to be delivered.

Learn the easy way! Drag packages into your cabin following your flying path; this will make things easier once you will reach your destinations!